

**NB1 WHEEL TO WHEEL RUNNING BOARDS
2019-24 SILVERADO/ SIERRA 1500 CREW CAB 6.5FT BED
(INCLUDES DIESEL MODELS W/DEF, 2022 SILVERADO 1500 LTD AND 2022 SIERRA 1500 LIMITED)**

PARTS LIST:

1	Driver/Left NB1 Running Board	32	10mm x 27mm OD x 3mm Flat Washers
1	Passenger/Right NB1 Running Board	16	10mm Nylon Lock Nuts
4	Driver/Left Mounting Brackets	16	8mm x 30mm Hex Bolts
4	Passenger/Right Mounting Brackets	16	8mm Lock Washers
16	10mm x 35mm Hex Bolts	16	8mm x 24mm OD x 2mm Flat Washers

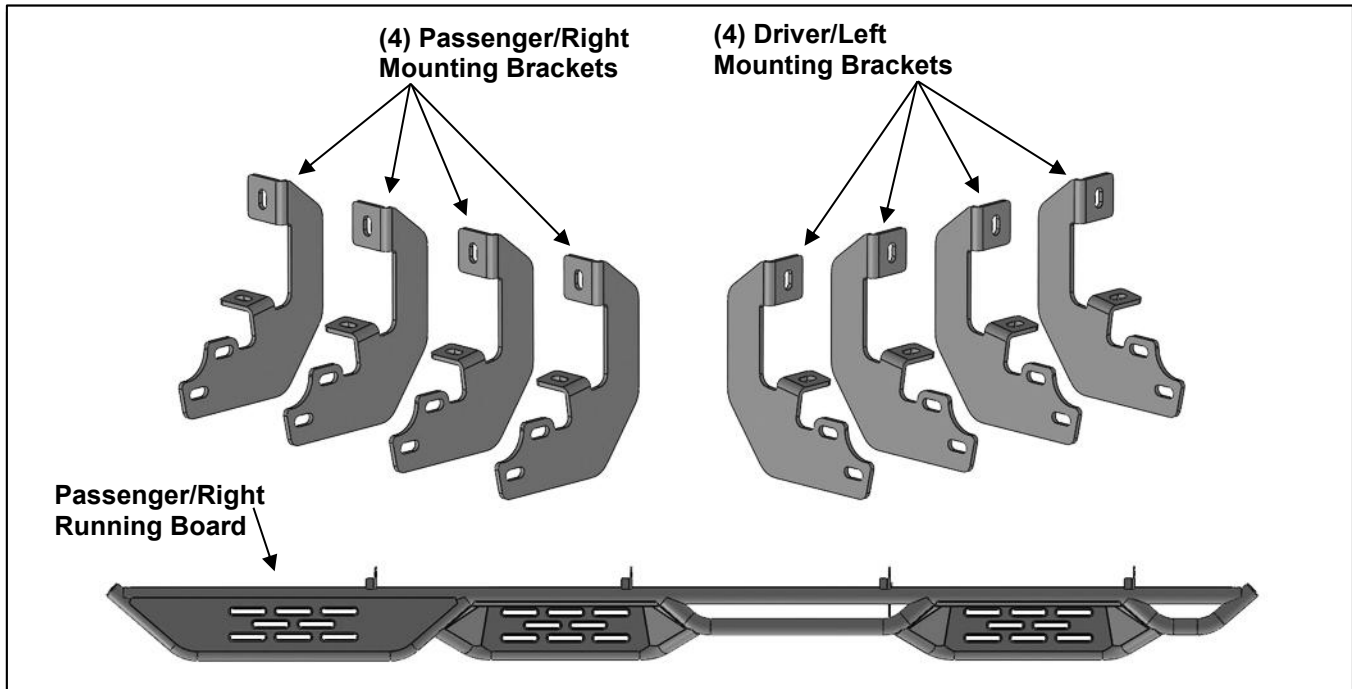

PROCEDURE:

REMOVE CONTENTS FROM BOX. VERIFY ALL PARTS ARE PRESENT. READ INSTRUCTIONS CAREFULLY BEFORE STARTING INSTALLATION. ASSISTANCE IS RECOMMENDED.

1. Start the installation under the Passenger/Right side of the vehicle.
 - a. For **“Early” 2019 models**, locate the 6 plugs along the bottom edge of the body. Mounting Brackets will bolt to the 1st, 3rd, 4th and 6th threaded mounting holes, **(Figure 1)**.
 - b. For **“Late” 2019 models**, all (4) mounting locations will be used.
2. Remove the plastic plugs from the Passenger/Right front mounting location. Select (1) Mounting Bracket. Attach the Mounting Bracket to the factory threaded holes with (2) 8mm Hex Bolts, (2) 8mm Lock Washers and (2) 8mm Flat Washers, **(Figures 2 & 3)**. Do not tighten hardware.
3. Repeat **Steps 1 & 2** to attach (3) Mounting Brackets to the (3) remaining locations along the rocker panel, **(Figures 4—7)**. Do not tighten hardware.
4. Select the Passenger/Right Running Board. With assistance, line up the slots on the mounting tabs on the Running Board to the slots in the rear faces of the (4) Mounting Brackets. Attach the Running Board to the (4) Mounting Brackets with (8) 10mm Flat Washers, (16) 10mm Flat Washers and (8) 10mm Nylon Lock Nuts, **(Figure 8)**. Do not tighten hardware.
5. Level and adjust the Running Board and fully tighten all hardware.
6. Repeat **Steps 1—5** to attach the Driver/Left Running Board.
7. Do periodic inspections to the installation to make sure that all hardware is secure and tight.

To protect your investment, Do not use any type of polish or wax that may contain abrasives that could damage the finish. Mild soap may be used also to clean the Running Boards.

**NB1 WHEEL TO WHEEL RUNNING BOARDS
2019-24 SILVERADO/ SIERRA 1500 CREW CAB 6.5FT BED
(INCLUDES DIESEL MODELS W/DEF, 2022 SILVERADO 1500 LTD AND 2022 SIERRA 1500 LIMITED)**

Passenger/Right side Installation Pictured

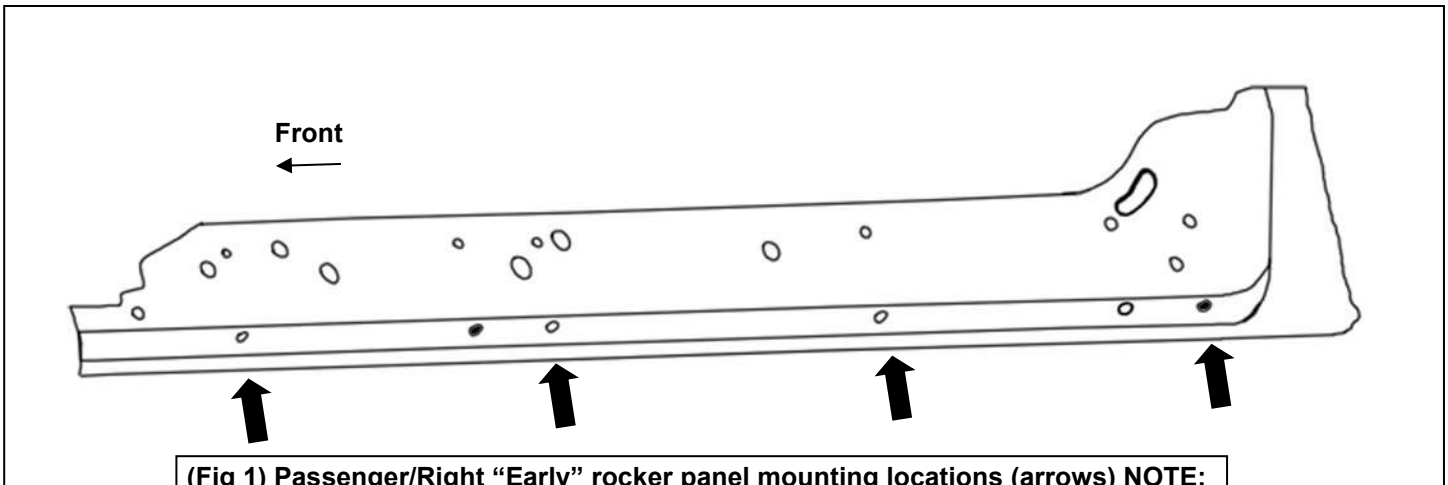

(Fig 1) Passenger/Right "Early" rocker panel mounting locations (arrows) NOTE: Hold Bracket up to body panel to help determine the correct mounting locations.

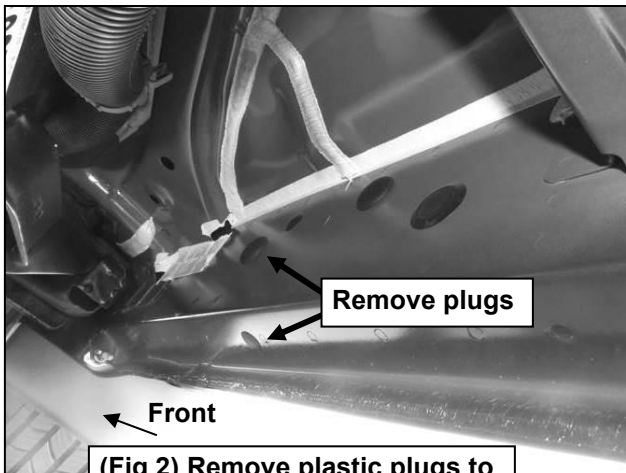

(Fig 2) Remove plastic plugs to uncover threaded inserts

- (2) 8mm Hex Bolts
- (2) 8mm Lock Washers
- (2) 8mm Flat Washers

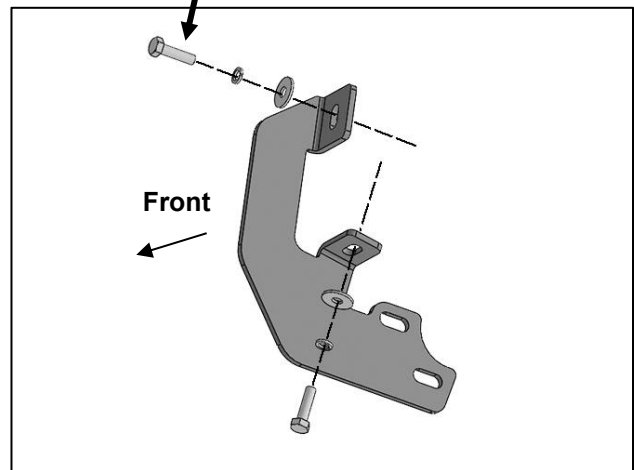

(Fig 3) Attach (1) Passenger/Right Mounting Bracket to the mounting location

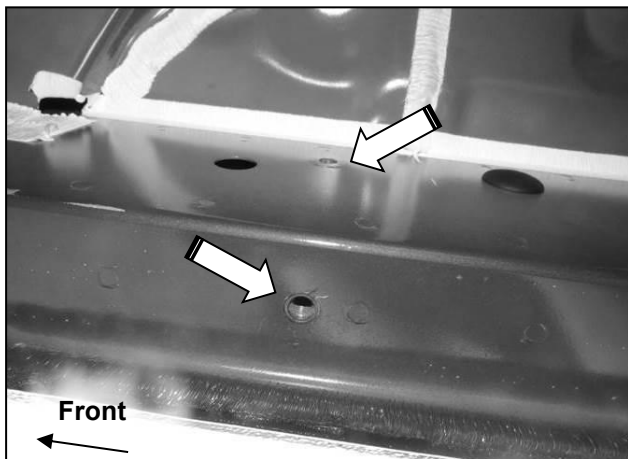

(Fig 4) Passenger/Right front mounting location

**NB1 WHEEL TO WHEEL RUNNING BOARDS
2019-24 SILVERADO/ SIERRA 1500 CREW CAB 6.5FT BED
(INCLUDES DIESEL MODELS W/DEF, 2022 SILVERADO 1500 LTD AND 2022 SIERRA 1500 LIMITED)**

Passenger/Right side Installation Pictured

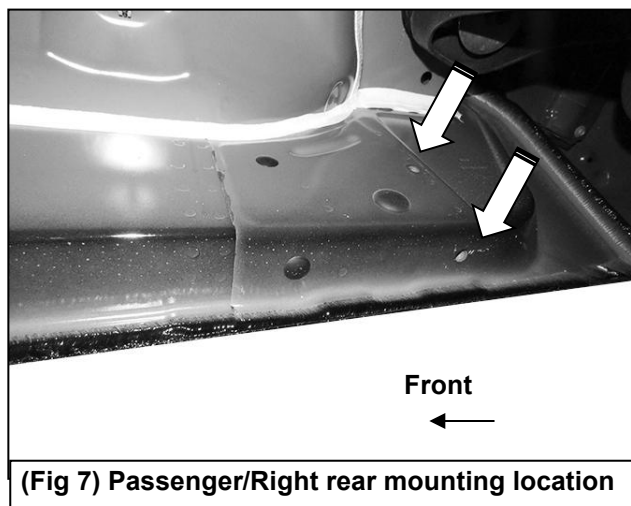
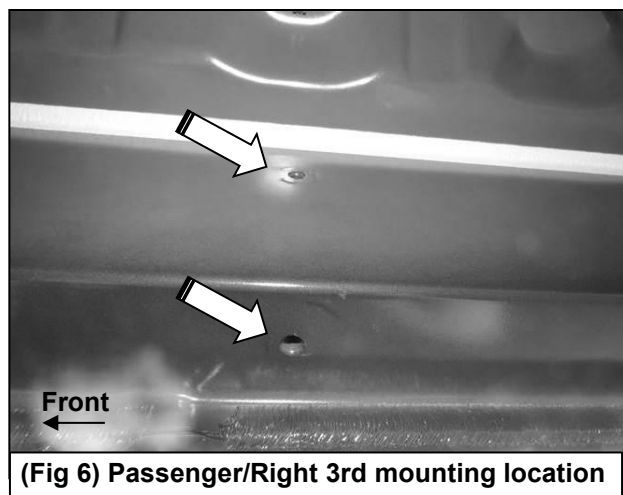
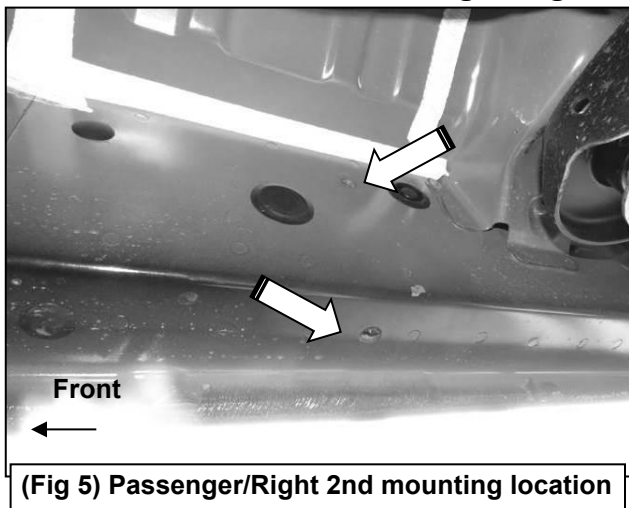

- (2) 10mm Hex Bolts**
- (2) 10mm Flat Washers**
- (2) 10mm Nylon Lock Nuts**

