



PART#: IB-P974Y&H

iBoard® Series

READ INSTRUCTIONS CAREFULLY BEFORE START ING INSTALLATION. REMOVE CONTENTS FROM BOX AND VERIFY ALL PARTS ARE PRESENT. ASSISTANCE IS RECOMMENDED.

*ROCKER PANEL MOUNT
*NO DRILLING REQUIRED

Fastener Size	Tightening Torque (ft-lbs)	Required
6mm	6-7	X
8mm	16-18	√
10mm	31-32	X
12mm	56-58	X
14mm	92-94	X

PART LIST

Driver Side Step Bar

Front



Passenger Side Step Bar

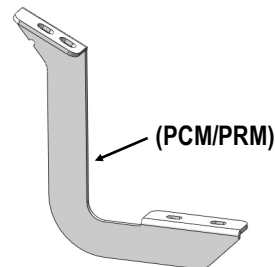
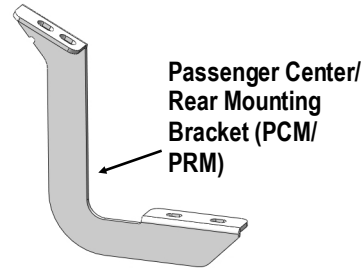
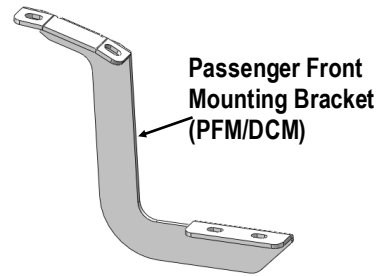
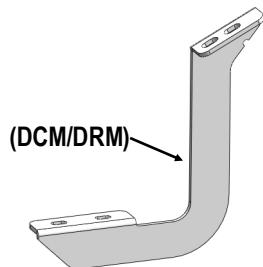
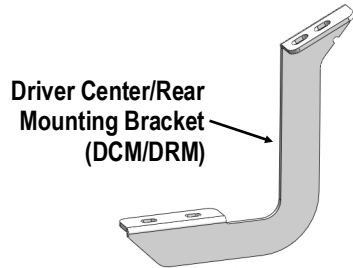
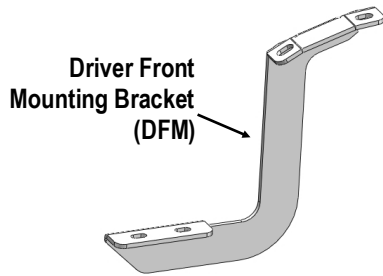



Scan for
Installation Video

Hardware Package A (For Bracket Installation)					
Item	QTY	Description	Item	QTY	Description
1#	12	M8X1.25-30mm Hex Bolts	3#	12	M8 Lock Washers
2#	12	M8 Large Flat Washers			



1#



2#



3#

Hardware Package B (For Step Bar Installation)					
Item	QTY	Description	Item	QTY	Description
1#	12	M8X1.25-35mm Carriage Bolts	3#	12	M8 Nylon Lock Nuts
2#	12	M8 Large Flat Washers	4#	6	Sliders (Packed with Mounting Brackets)

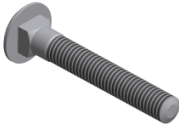

1#



2#



3#



4#



STEP 1

Start installation from the Passenger side of the vehicle, remove the existing (2) factory bolts on the mounting locations on rocker panel, (Figs 1 & 2).

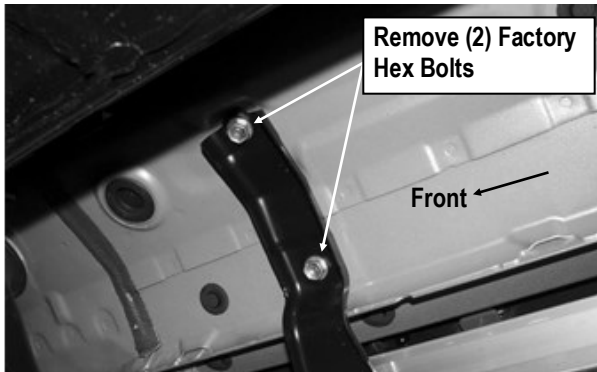

(Fig 1) Passenger Side Front Mounting Location



(Fig 2) Passenger Side Rear Mounting Location

STEP 2

Select (1) Passenger Front Mounting Bracket. Attach the bracket over the factory bracket with (2) M8x1.25-30mm Hex Bolts, (2) M8 Large Flat Washers and (2) M8 Lock Washers (Fig 3). Do not fully tighten hardware at this time.

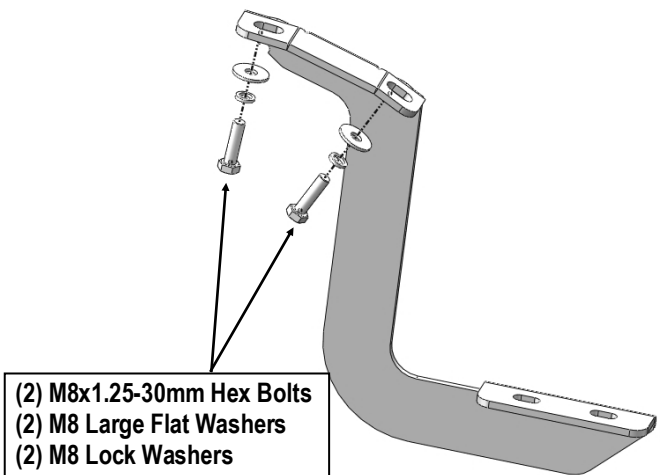

(Fig 3) Passenger Front Mounting Bracket Installation

STEP 3

Move to center & rear mounting locations. Repeat Steps 1-2 to install the Passenger Center & Rear Mounting Brackets.

Note: Passenger Center & Rear Mounting Bracket are universal .



STEP 5

Once all (3) Passenger side mounting brackets are installed, then proceed to the Step Bar installation. **(Figs 4 & 5)**

- (1) Select (1) Slider and (2) M8X1.25-35mm Carriage Bolts;
- (2) Install (2) M8X1.25-35mm Carriage Bolts in (1) Slider.
- (3) Slide the Slider (with carriage bolts) to the **Step Bar**.
- (4) Repeat to install the other (2) sliders to the step bar.
- (5) Attach the Step Bar (with the Sliders) onto the installed mounting brackets. Position the Sliders to the installed brackets. Secure the Step Bar to the installed Brackets by using (6) M8 Large Flat Washers and (6) M8 Nylon Lock Nuts and (3) Sliders, **(Fig 5)**. Do not fully tighten hardware at this time.

Note: The Sliders are packed with the Mounting Brackets.

Level and adjust the Step Bar and fully tighten all hardware.

Repeat **Steps 1-5** for the other side Step Bar installation. **The installation is completed!!!**

Attention

Do periodic inspections to the installation to make sure that all hardware is secure and tight.

In order to protect your bars/boards, please use mild soap/non-abrasive products for cleaning only.

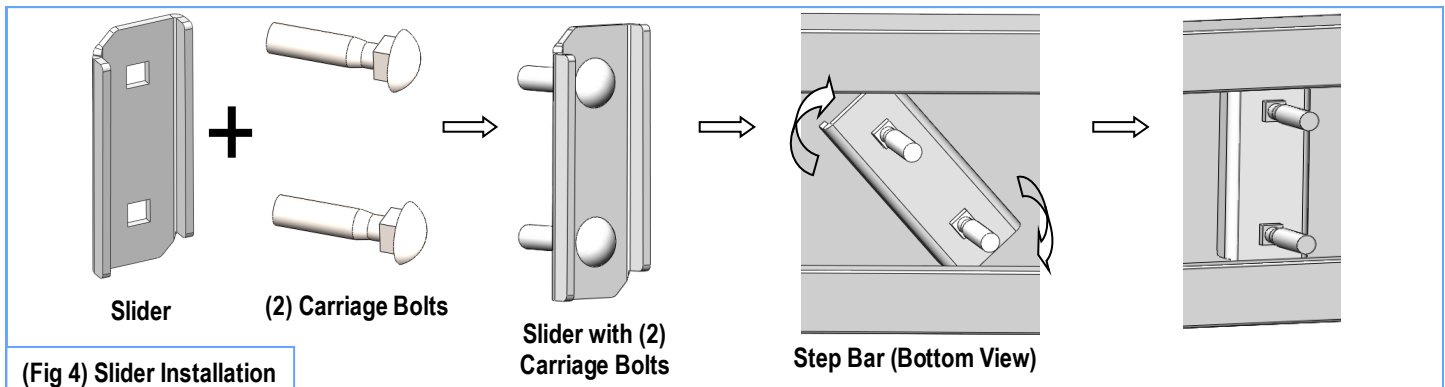

(Fig 4) Slider Installation

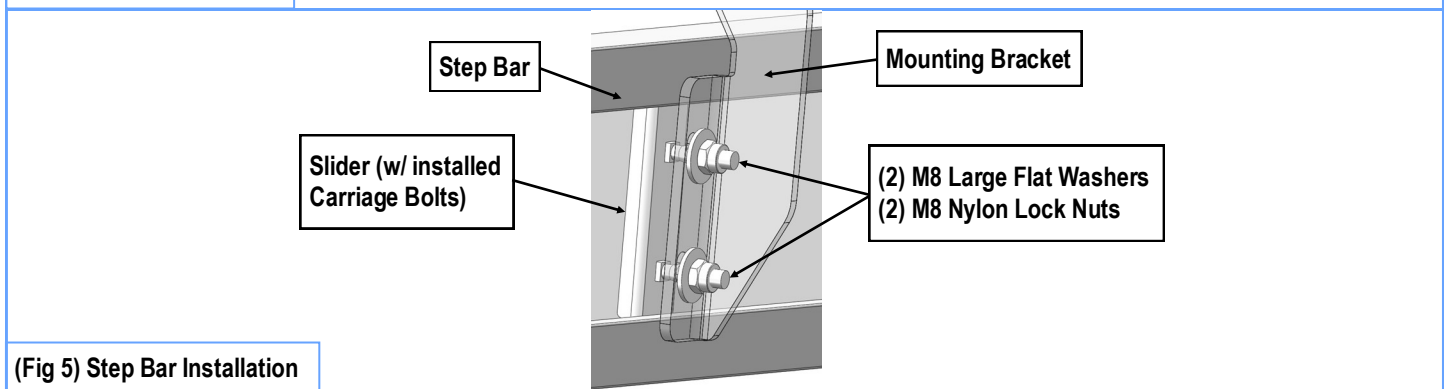

(Fig 5) Step Bar Installation