



iBoard® by APS

PART#: IB-050[L,S] C&H

READ INSTRUCTIONS CAREFULLY BEFORE STARTING INSTALLATION. REMOVE CONTENTS FROM BOX AND VERIFY ALL PARTS ARE PRESENT. ASSISTANCE IS RECOMMENDED.

*ROCKER PANEL MOUNT
*NO DRILLING REQUIRED

Fastener Size	Tightening Torque (ft-lbs)	Required
6mm	6-7	X
8mm	16-18	√
10mm	31-32	√
12mm	56-58	X
14mm	92-94	X



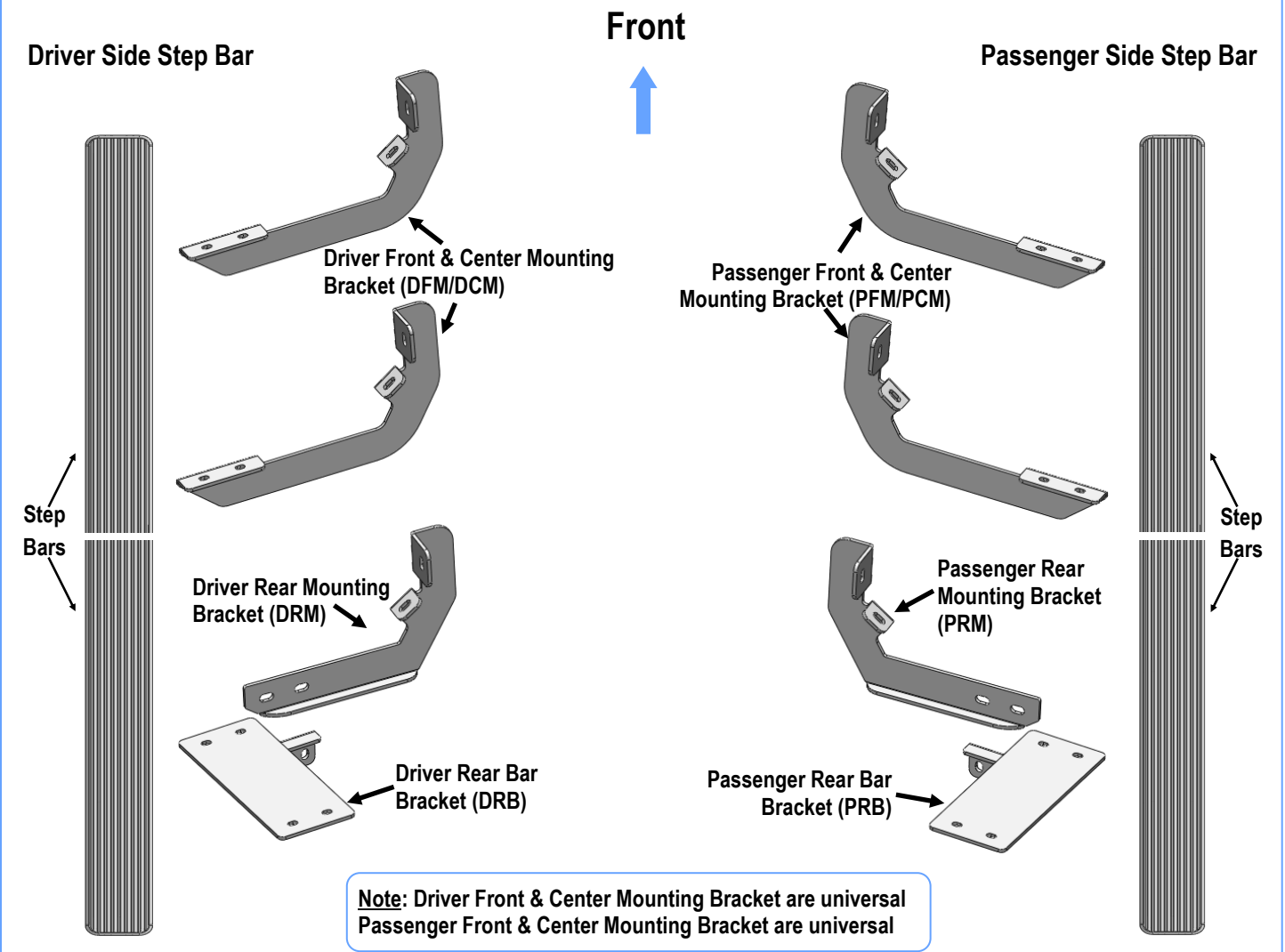





PART LIST

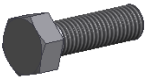





Hardware Package A (For Bracket Installation)

Item	QTY	Description	Item	QTY	Description
1#	12	M8X1.25-30mm Hex Bolts	5#	4	M10X1.5-30mm Hex Bolts
2#	12	M8 Large Flat Washers	6#	8	M10 Flat Washers
3#	12	M8 Lock Washers	7#	4	M10 Lock Washers
4#	6	M8X1.25 Nylon Lock Nuts	8#	4	M10X1.5 Hex Nuts

							
1 #	2 #	3 #	4 #	5 #	6 #	7 #	8 #



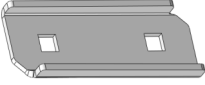

Hardware Package B (For Stainless Steel Step Bar Installation)

Item	QTY	Description	Item	QTY	Description
1#	16	M8X1.25-35mm Carriage Bolts	3#	16	M8 Nylon Lock Nuts
2#	16	M8 Large Flat Washers	4#	8	Sliders (Packed with Step Bars)

			
1 #	2 #	3 #	4 #

Hardware Package C (For Stainless Steel Step Bar Assembly)

Item	QTY	Description	Item	QTY	Description
1#	8	Plastic Rivets	5#	4	M8 Hex Nuts
2#	12	M8X1.25-25mm Inner Hex Bolts	6#	2	Plastic Covers (Packed with Step Bars)
3#	16	M8 Flat Washers	7#	2	Back Plates (Packed with Step Bars)
4#	12	M8 Lock Washers			

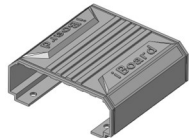
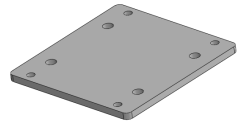
						
1 #	2 #	3 #	4 #	5 #	6 #	7 #



STEP 1

Step Bar Assembly:

1. Select and assemble (2) Step Bars with (2) M8X1.25-25mm Inner Hex Bolts, (4) M8 Flat Washers, (2) M8 Lock Washers and (2) M8 Hex Nuts, (**Fig 1**). **NOTE: (4) Step Bars are universal.**
2. Attach (1) Back Plate to the bottom of the installed (2) Step Bars with (4) M8X1.25-25mm Inner Hex Bolts, (4) M8 Flat Washers, (4) M8 Lock Washers, (**Fig 2**).
3. Install (1) Plastic Cover to cover the joint of (2) Step bars with (4) Plastic Rivets, (**Fig 3**).
4. Repeat to assemble the other (2) Step Bars.

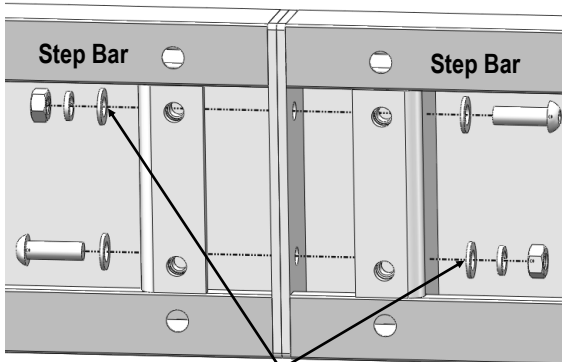

- (2) M8X1.25-25mm Inner Hex Bolts
- (4) M8 Flat Washers
- (2) M8 Lock Washers
- (2) M8 Hex Nuts

(Fig 1) Step Bars Assembly

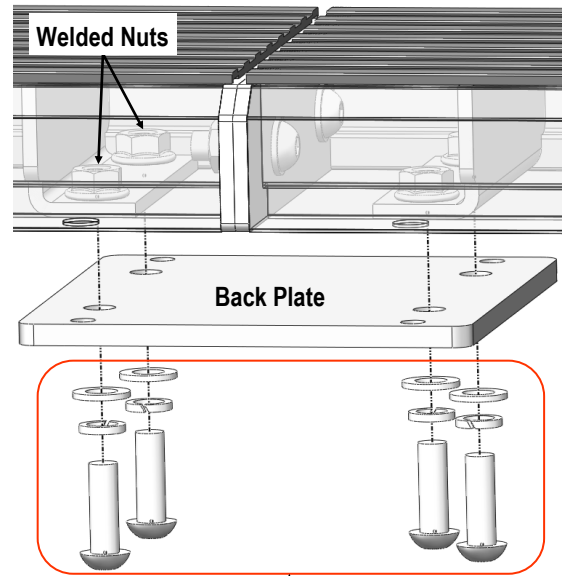

- (4) M8X1.25-25mm Inner Hex Bolts
- (4) M8 Flat Washers
- (4) M8 Lock Washers

(Fig 2) Back Plate Installation

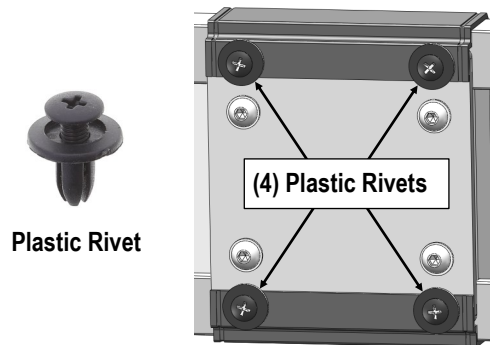

(Fig 3) Plastic Cover Installation
(Bottom View)

Assembled Step Bars





STEP 2

Start installation from the driver side front of the vehicle, locate the factory threaded holes or stud located on the side of the inner body panel, **(Figs 4 & 5)**. **NOTE:** Remove the plastic plug or any insulation on the side panel to locate the threaded holes.

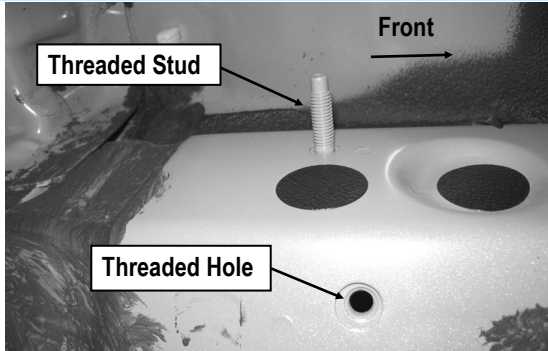

(Fig 4) Up To 2015 Driver Side Rear Mounting Location
(Note: Remove Plastic Plug To Locate Factory Threaded Hole)

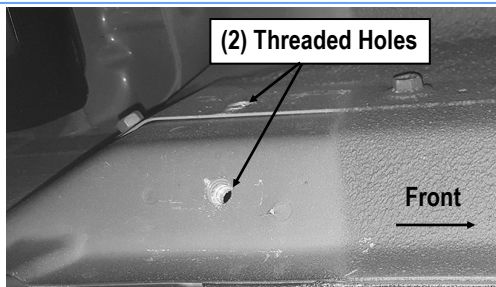

(Fig 5) 2016-On Driver Side Rear Mounting Location
(Note: Two Factory Threaded Holes Only)

STEP 3

Attach (1) Driver Front Mounting Bracket (**DFM/DCM**) onto the Driver Side Front Mounting Location as shown **(Fig 6)**.

- a. **Models with threaded stud:** Attach the Mounting Bracket to stud with (1) M8 Flat Washer, (1) M8X1.25 Nylon Lock Nut. Next, secure the bracket to the lower threaded hole with (1) M8X1.25-25mm Hex Bolt, (1) M8 Flat Washer and (1) M8 Lock Washer. Do not tighten hardware at this time.
- b. **Models without threaded stud:** Attach the Mounting Bracket to the upper threaded hole with (1) M8X1.25-25mm Hex Bolt, (1) M8 Flat Washer and (1) M8 Lock

Washer. Next, secure the bracket to the lower threaded hole with (1) M8X1.25-25mm Hex Bolt, (1) M8 Flat Washer and (1) M8 Lock Washer, **(Fig 7)**. Do not fully tighten hardware at this time.

There are (4) mounting locations along the body panel. Bracket installation will use the 1st, 2nd and 4th mounting locations. Repeat to Install the Driver Center Mounting Bracket.

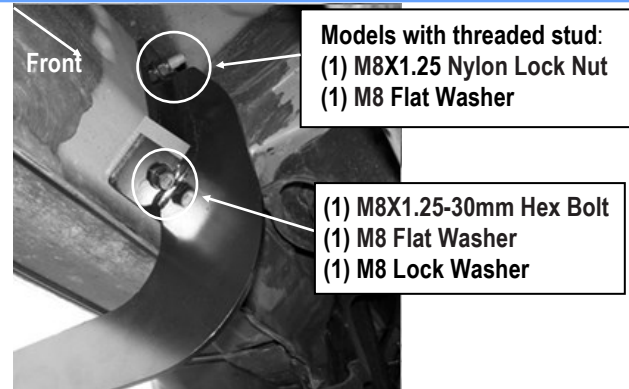

(Fig 6) Models With Threaded Stud Bracket Installed

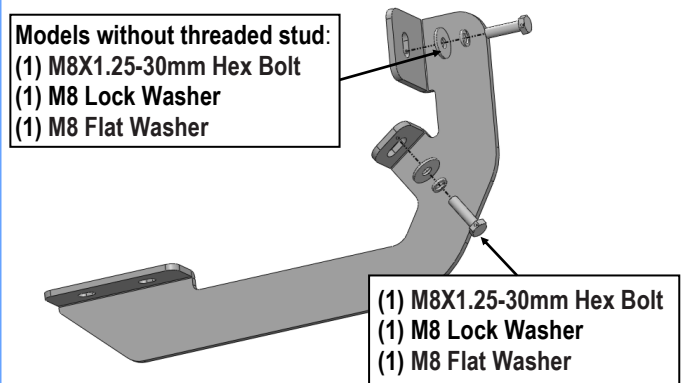

(Fig 7) Models Without Threaded Stud Bracket Installation

STEP 4

Assemble (1) Driver Rear Mounting Bracket (**DRM**) and (1) Driver Rear Bar Bracket (**DRB**) with (2) M10X1.5-30mm Hex Bolts, (2) M10 Lock Washers, (4) M10 Flat Washers and (2) M10X1.5 Hex Nuts, **(Fig 8)**. Do not fully tighten hardware at this time.

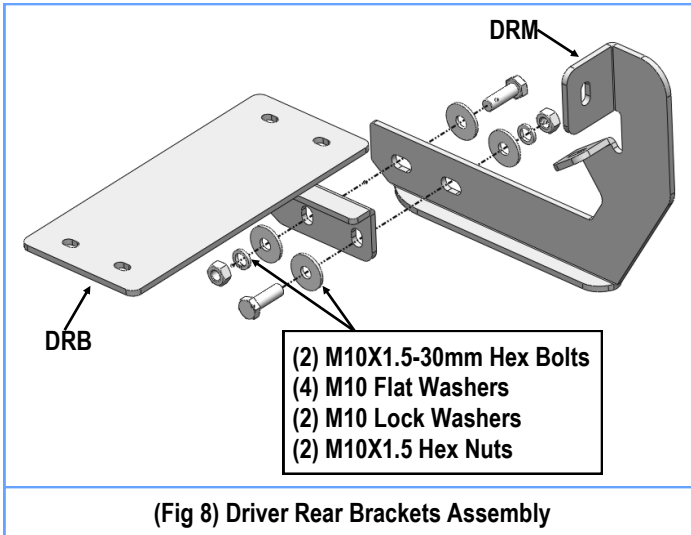

Attention

Do periodic inspections to the installation to make sure that all hardware is secure and tight.

In order to protect your bars/boards, please use mild soap/non-abrasive products for cleaning only.

STEP 5

Next, move to the driver side rear mounting location at the back of the cab. Repeat **Steps 2 & 3** to install the assembled driver rear bracket. Do not fully tighten hardware at this time.

STEP 6

Once all (3) Driver side mounting brackets are installed, then proceed to the Step Bar installation. (**Figs 9 & 10**)

- (1) Select (1) Slider and (2) M8X1.25-35mm Carriage Bolts;
- (2) Install (2) M8X1.25-35mm Carriage Bolts in (1) Slider.
- (3) Slide the Slider (with carriage bolts) to the **Step Bar**.
- (4) Repeat to install the other (2) sliders to the step bar.
- (5) Attach the Step Bar (with the Sliders) onto the installed mounting brackets. Position the Sliders to the installed brackets. Secure the Step Bar to the installed Brackets by using (8) M8 Large Flat Washers and (8) M8 Nylon Lock Nuts and (4) Sliders, (**Fig 10**). Do not fully tighten hardware at this time.

Note: The Sliders are packed with the Step Bars.

Level and adjust the Step Bar and fully tighten all hardware.

Repeat **Steps 2-6** for the other side Step Bar installation. **The installation is completed!!!**

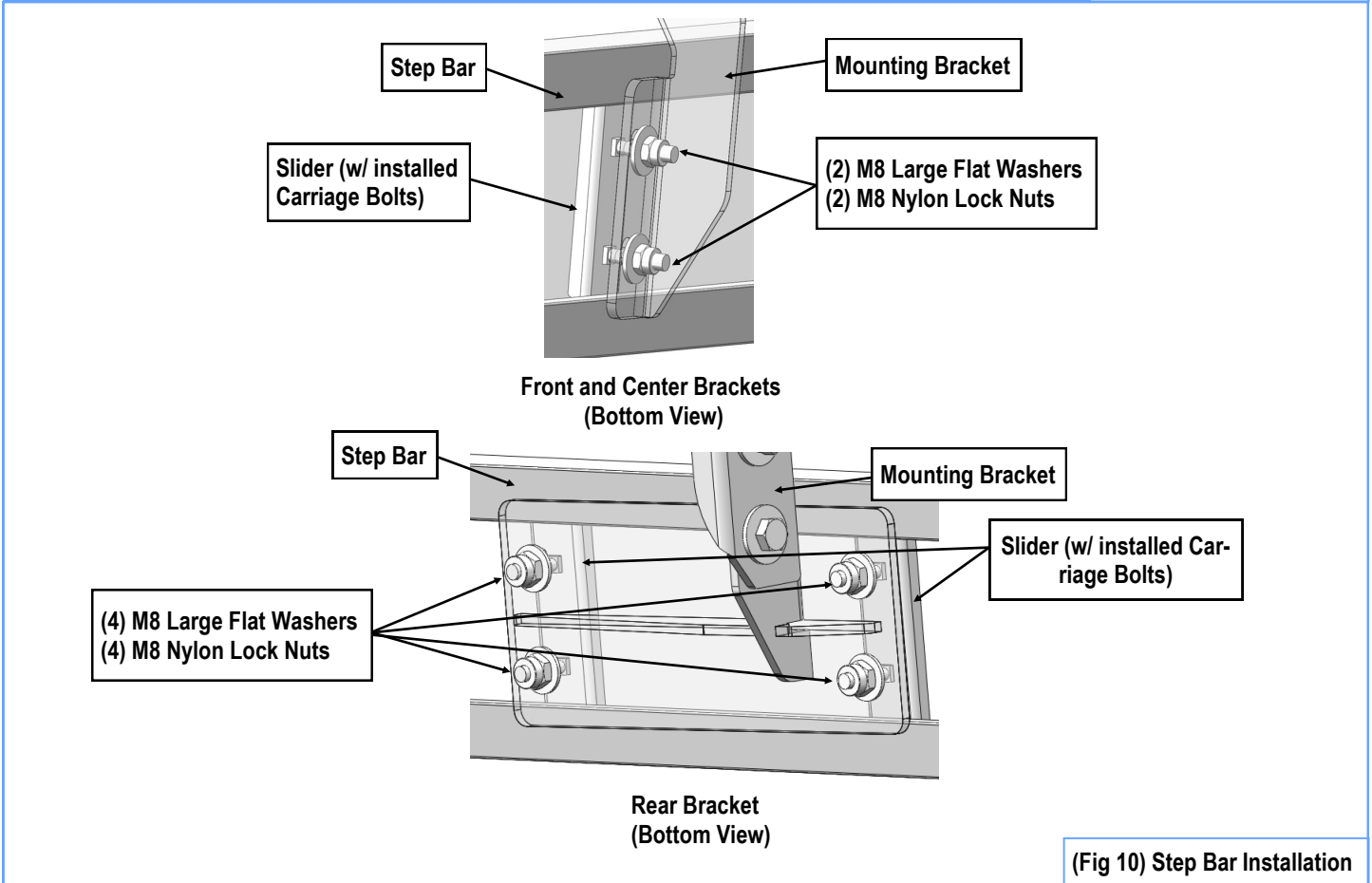
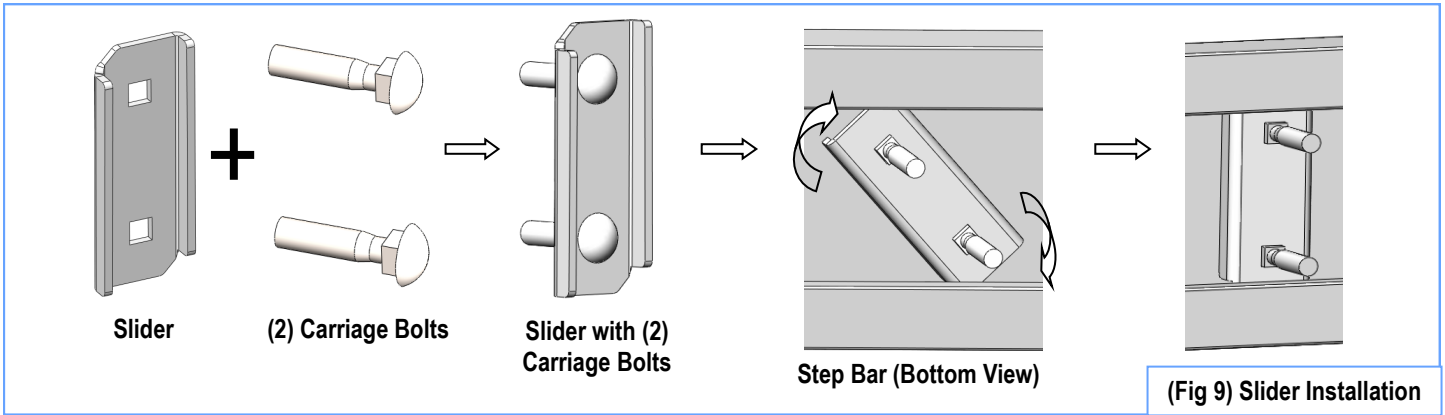

(Fig 10) Step Bar Installation