

iBoard®



Scan for
Installation Video

iBoard® by APS

PART#: IB-P181Y&H

READ INSTRUCTIONS CAREFULLY BEFORE STARTING INSTALLATION. REMOVE CONTENTS FROM BOX AND VERIFY ALL PARTS ARE PRESENT. ASSISTANCE IS RECOMMENDED.

*ROCKER PANEL MOUNT
*NO DRILLING REQUIRED

Fastener Size	Tightening Torque (ft-lbs)	Required
6mm	6-7	X
8mm	16-18	√
10mm	31-32	X
12mm	56-58	X
14mm	92-94	X

PART LIST

Driver Side Step Bar



Driver Front
Mounting
Bracket (DFM)

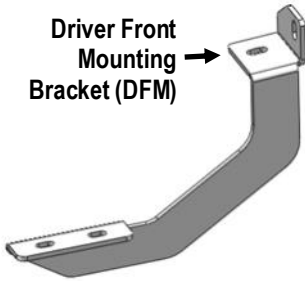

Driver Center
Mounting
Bracket (DCM)

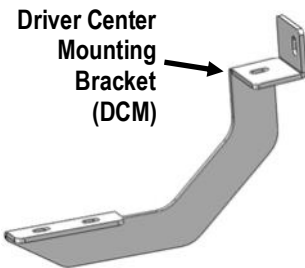

Driver Rear
Mounting
Bracket (DRM)

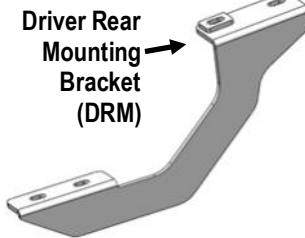

Front



Passenger Side Step Bar



Passenger
Front Mounting
Bracket (PFM)

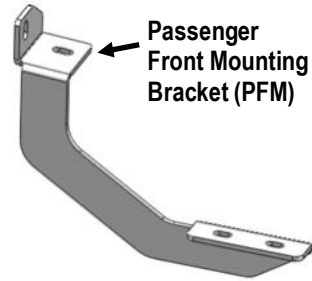

Passenger Center
Mounting Bracket (PCM)

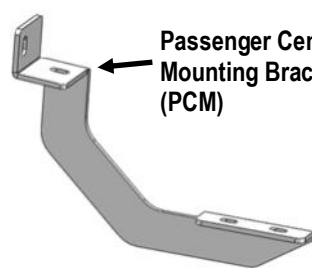

Passenger Rear
Mounting Bracket (PRM)

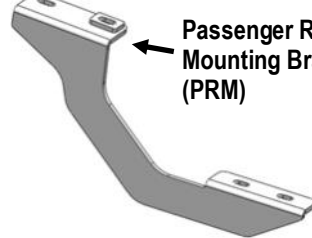

Customer Support: info@iboardauto.com



Scan for
Installation Video

Hardware Package A (For Bracket Installation)

Item	QTY	Description	Item	QTY	Description
1#	8	M8X1.25-25 Hex Bolts	3#	12	M8 Lock Washers
2#	12	M8 Large Flat Washers	4#	4	M8X1.25 Hex Nuts



1#



2#



3#



4#

Hardware Package B (For Step Bar Installation)

Item	QTY	Description	Item	QTY	Description
1#	12	M8X1.25-35mm Carriage Bolts	3#	12	M8 Nylon Lock Nuts
2#	12	M8 Large Flat Washers	4#	6	Sliders (Packed with Mounting Brackets)



1#



2#



3#



4#



STEP 1

Starting on the Driver side front of the vehicle. Locate (1) threaded stud and (1) threaded insert on the body panel, remove the plug on the threaded insert if equipped, (Fig 1).

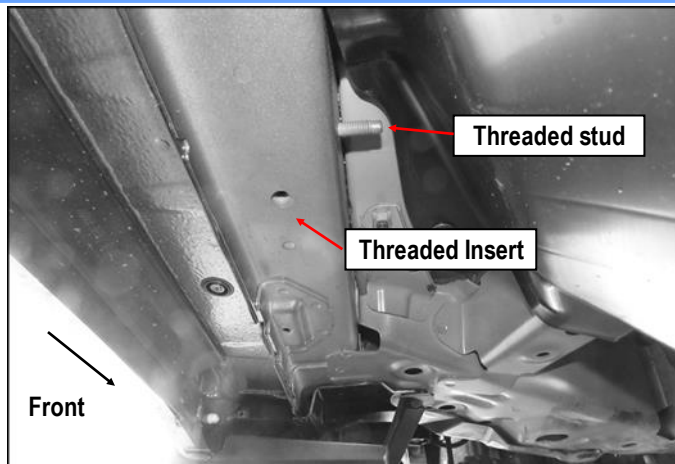

(Fig 1) Driver Side Front Mounting Location

STEP 2

Attach Driver Front Mounting Bracket (DFM) to the threaded stud with (1) M8 Large Flat Washer, (1) M8 Lock Washer and (1) M8X1.25 Hex Nut. Secure the lower hole of the mounting bracket to the threaded insert with (1) M8 Large Flat Washer, (1) M8 Lock Washer and (1) M8X1.25-25mm Hex Bolt. Do not fully tighten hardware at this time. (Figs 2&3).

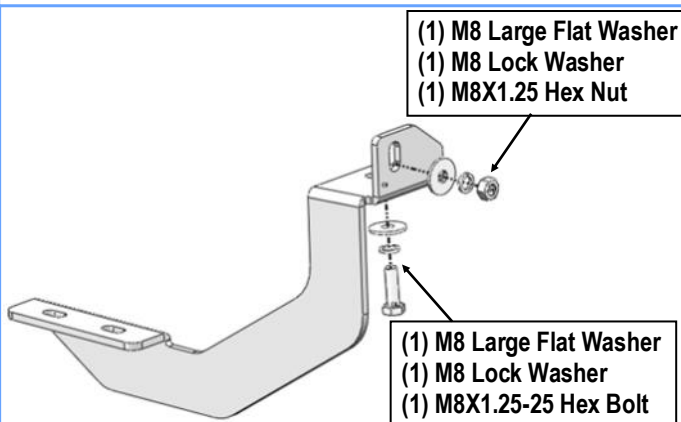

(Fig 2) Driver Front Mounting Bracket Installation

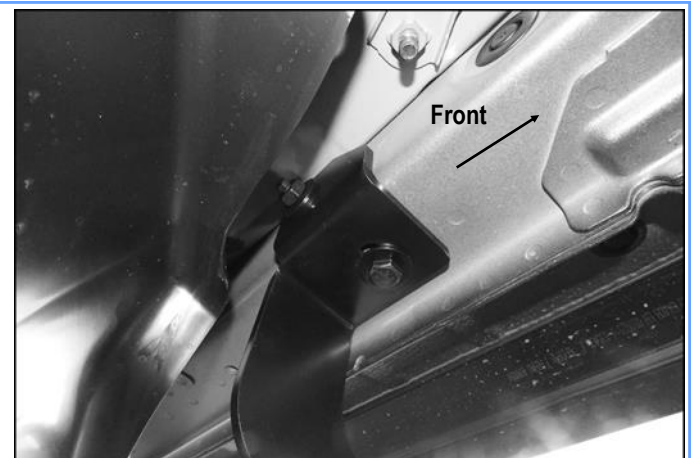

(Fig 3) Driver Front Mounting Bracket Installed

STEP 3

Move to the Driver side Center Mounting Location, (Fig 4). Repeat **Step 2** to install Driver Center Mounting Bracket (DCM), (Fig 5). Do not fully tighten hardware at this time.

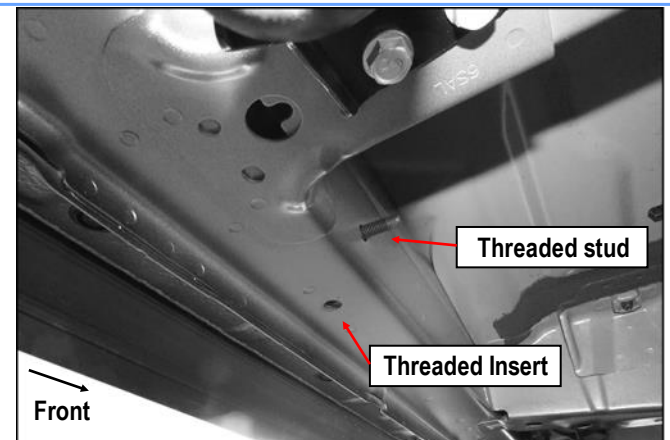

(Fig 4) Driver Side Center Mounting Location

STEP 4

Move to Driver side Rear Mounting Location. Locate two threaded holes on the body panel. Install Driver Rear Mounting Bracket with (2) M8X1.25-25 Hex Bolts, (2) M8 Lock Washers, and M8 Flat Washers, (Figs 6-8). Do not fully tighten hardware at this time.

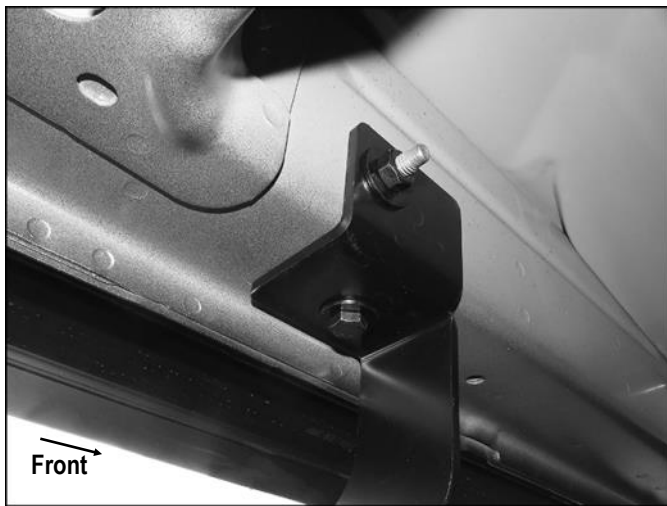

(Fig 5) Driver Center Mounting Bracket Installed



(Fig 8) Driver Rear Mounting Bracket Installed

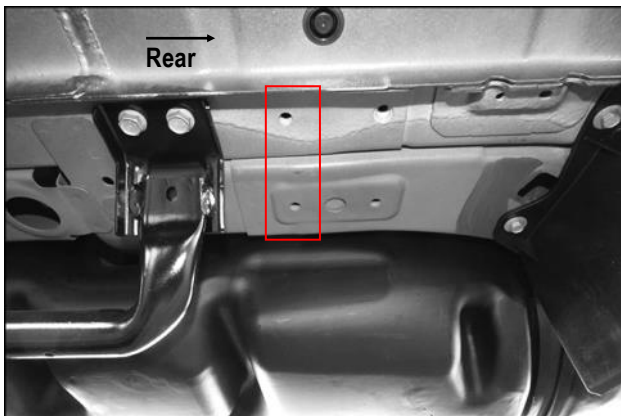

(Fig 6) Driver Side Rear Mounting Location

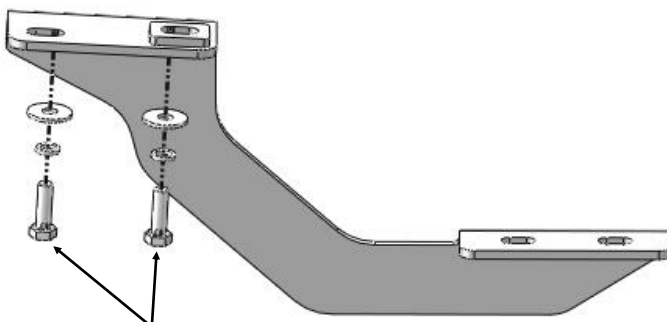

(2) M8 Large Flat Washers
(2) M8 Lock Washers
(2) M8X1.25-25 Hex Bolts

(Fig 7) Driver Rear Mounting Bracket Installation

STEP 5

Once all (2) Driver side mounting brackets are installed, then proceed to the Step Bar installation. (Figs 9 & 10)

- (1) Select (1) Slider and (2) M8X1.25-35mm Carriage Bolts;
- (2) Install (2) M8X1.25-35mm Carriage Bolts in (1) Slider.
- (3) Slide the Slider (with carriage bolts) to the **Step Bar**.
- (4) Repeat to install the other (1) slider to the step bar.

- (5) Attach the Step Bar (with the Sliders) onto the installed mounting brackets. Position the Sliders to the installed brackets. Secure the Step Bar to the installed Brackets by using (6) M8 Large Flat Washers and (6) M8 Nylon Lock Nuts and (3) Sliders, (Fig 10). Do not fully tighten hardware at this time.

Note: The Sliders are packed with the Mounting Brackets.

Level and adjust the Step Bar and fully tighten all hardware.

Repeat **Steps 1-5** for the other side Step Bar installation. **The installation is completed!!!**

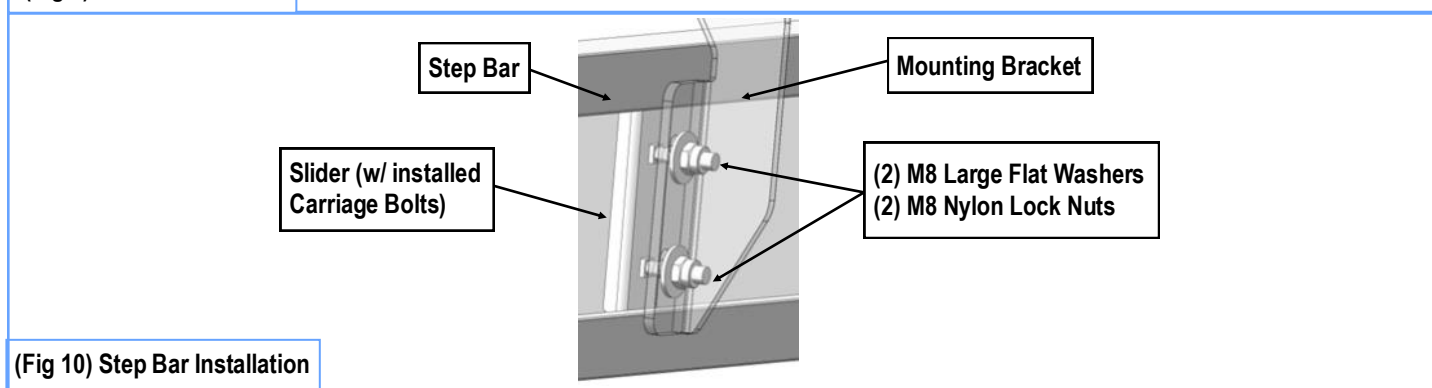
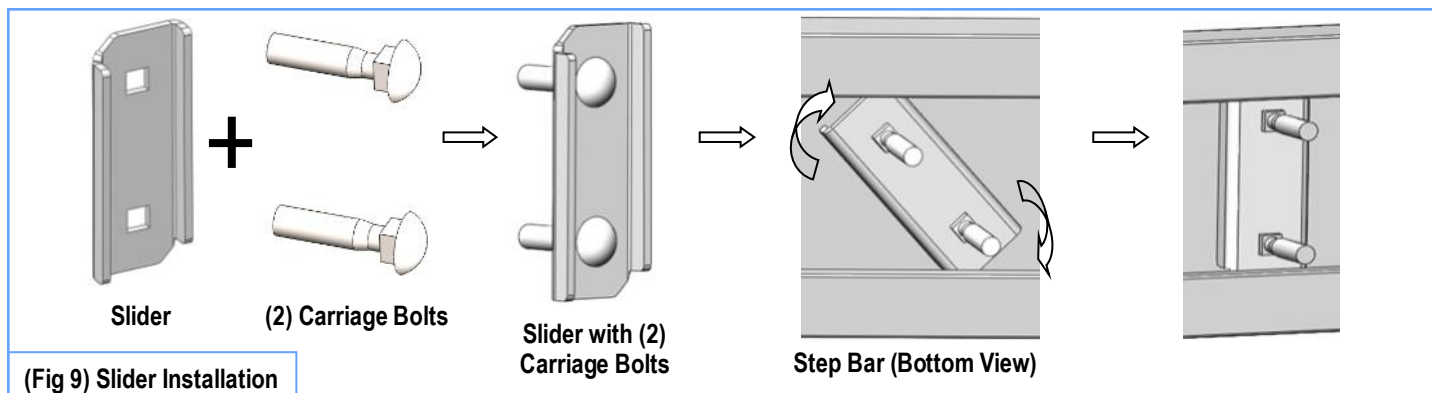

Attention

Do periodic inspections to the installation to make sure that all hardware is secure and tight.
In order to protect your bars/boards, please use mild soap/non-abrasive products for cleaning only.