

iBoard®



Scan for
Installation Video

iBoard® by APS

PART#: IB-P120Y&H

READ INSTRUCTIONS CAREFULLY BEFORE STARTING INSTALLATION. REMOVE CONTENTS FROM BOX AND VERIFY ALL PARTS ARE PRESENT. ASSISTANCE IS RECOMMENDED.

*ROCKER PANEL MOUNT
*NO DRILLING REQUIRED

| Fastener Size | Tightening Torque (ft-lbs) | Required |
|---------------|----------------------------|----------|
| 6mm | 6-7 | √ |
| 8mm | 16-18 | √ |
| 10mm | 31-32 | X |
| 12mm | 56-58 | √ |
| 14mm | 92-94 | X |

PART LIST

Driver Side Step Bar



Front



Passenger Side Step Bar

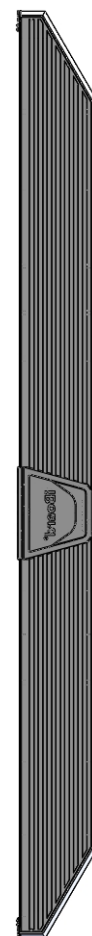

Driver Front Mounting
Bracket (DFM)

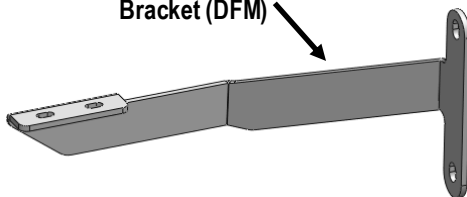

Passenger Front Mounting
Bracket (PFM)

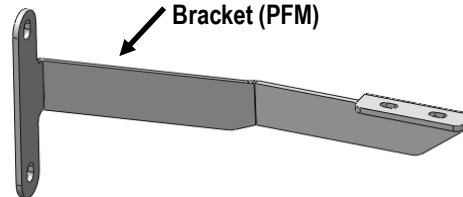

Driver Rear Mounting
Bracket (DRM)

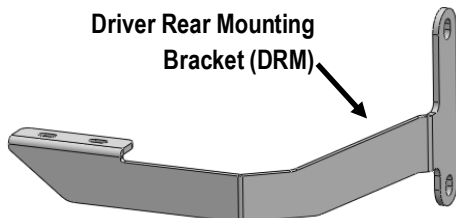

Passenger Rear Mounting
Bracket (PRM)

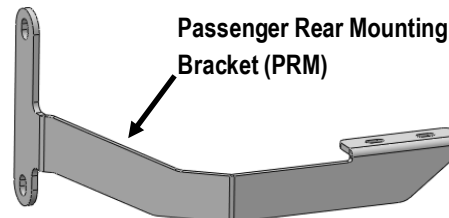

Customer Support: info@iboardauto.com



Hardware Package A (For Bracket Installation)

| Item | QTY | Description | Item | QTY | Description |
|------|-----|------------------------|------|-----|-----------------------|
| 1# | 6 | Stop Spacers | 5# | 8 | M12 Hex Nuts |
| 2# | 4 | M12 U-Bolts | 6# | 3 | M6X1-30mm Hex Bolts |
| 3# | 8 | M12 Large Flat Washers | 7# | 3 | M6 Lock Washers |
| 4# | 8 | M12 Lock Washers | 8# | 3 | M6 Large Flat Washers |

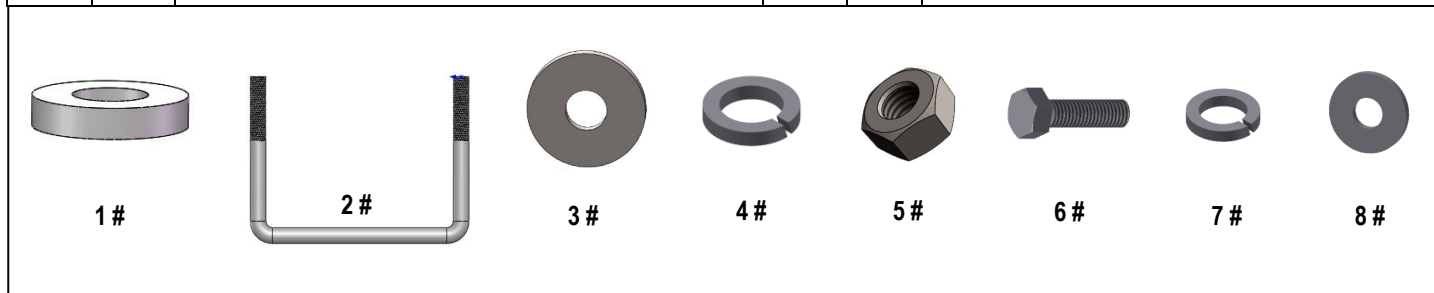

Hardware Package B (For Step Bar Installation)

| Item | QTY | Description | Item | QTY | Description |
|------|-----|-----------------------------|------|-----|---|
| 1# | 8 | M8X1.25-35mm Carriage Bolts | 3# | 8 | M8 Nylon Lock Nuts |
| 2# | 8 | M8 Large Flat Washers | 4# | 4 | Sliders (Packed with Mounting Brackets) |

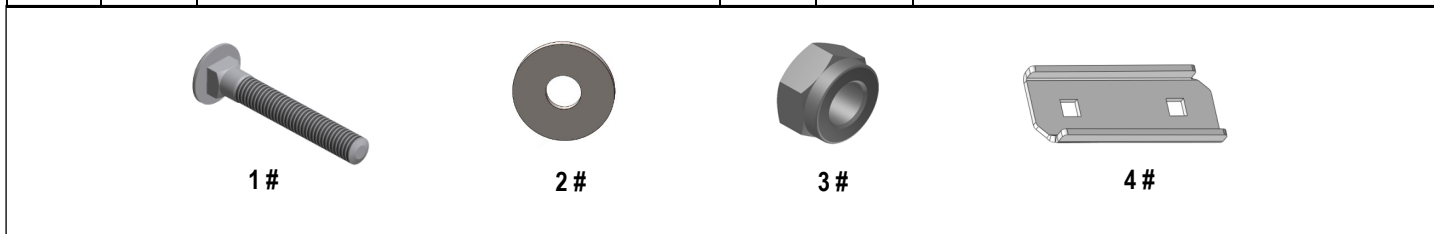



STEP 1

Start installation from the driver side front of the vehicle. Insert (1) M12 U-Bolt to back plate with as shown, (Figs 1 & 2).

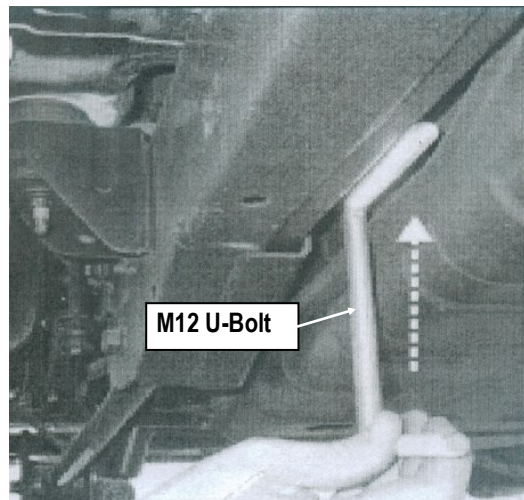

(Fig 1) M12 U-Bolt Installation

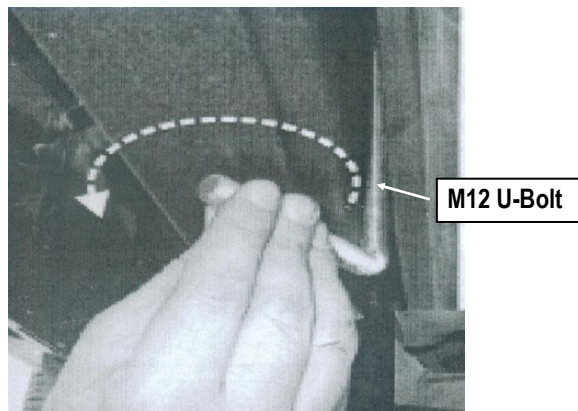

(Fig 2) M12 U-Bolt Installation

STEP 2

Install (12) Stop Spacers to the factory threaded hole to hold the M12 U-Bolt in the position with (1) M6X1-30mm Hex Bolt and (1) M6 Lock Washer, as shown (Fig 3).

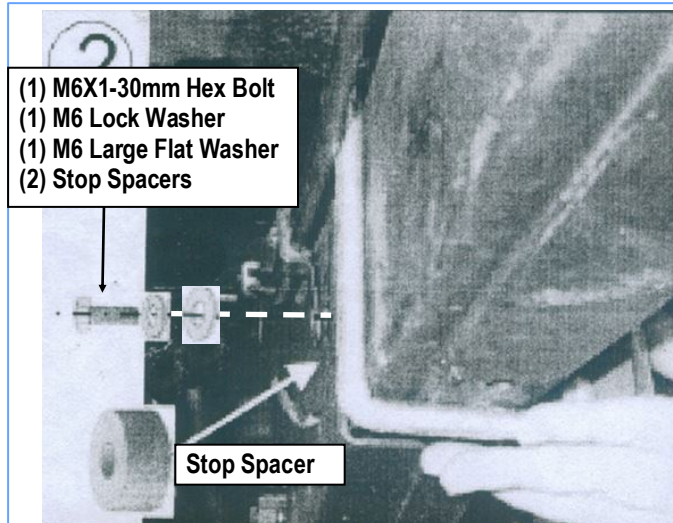

(Fig 3) Stop Spacer Installation

STEP 3

Attach the Driver Front Mounting Bracket (DFM) to M12 U-Bolt with (2) M12 Large Flat Washers, (2) M12 Lock Washers and (2) M12 Hex Nuts, (Figs 4 & 5). Do not fully tighten hardware at this time.

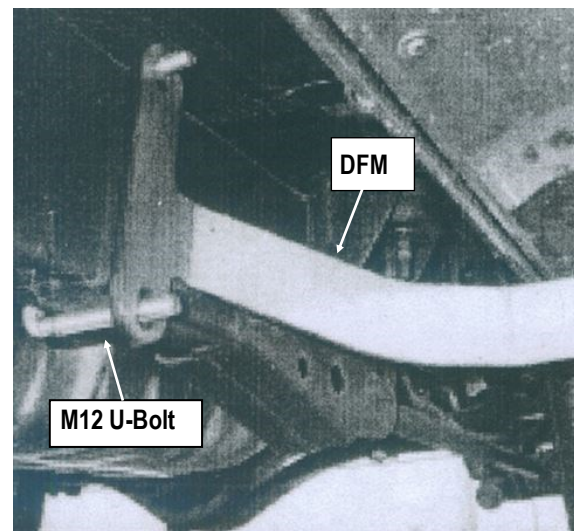

(Fig 4) Driver Front Mounting Bracket Installation

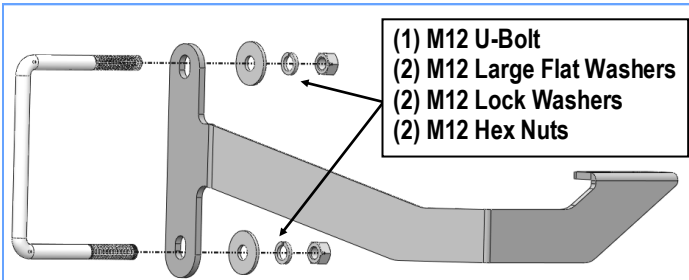

(Fig 5) Driver Front Mounting Bracket Installation

STEP 4

Move to driver side rear mounting location. Repeat **Steps 1-3** for Driver Rear Mounting Bracket (**DRM**) installation. Do not fully tighten hardware at this time.

STEP 5

Once all (2) Driver side mounting brackets are installed, then proceed to the Step Bar installation. (**Figs 6 & 7**)

- (1) Select (1) Slider and (2) M8X1.25-35mm Carriage Bolts;
- (2) Install (2) M8X1.25-35mm Carriage Bolts in (1) Slider.
- (3) Slide the Slider (with carriage bolts) to the **Step Bar**.
- (4) Repeat to install the other (1) slider to the step bar.
- (5) Attach the Step Bar (with the Sliders) onto the installed mounting brackets. Position the Sliders to the installed brackets. Secure the Step Bar to the installed Brackets by using (4) M8 Large Flat Washers and (4) M8 Nylon Lock Nuts and (2) Sliders, (**Fig 7**). Do not fully tighten hardware at this time.

Note: The Sliders are packed with the Mounting Brackets. Level and adjust the Step Bar and fully tighten all hardware.

STEP 6

Move to the Passenger Side Front Mounting Location of the vehicle. Repeat **Steps 1-3** to install the Passenger Front Mounting Bracket.

STEP 7

Move to the Passenger Side Rear Mounting Location. Remove the factory break line holder, flip up the break line rubber holder, and then reinstall the break line holder as shown on (**Fig 8**).

And then, repeat Steps 1-3 to install the Passenger Rear Mounting Bracket.

NOTE: Stop Spacer is not required on the Passenger Side Rear Mounting Location.

Repeat Step 5 to install the Passenger Side Step Bar.

Level and adjust the Step Bar and fully tighten all hardware.

The installation is completed!!!

Attention

Do periodic inspections to the installation to make sure that all hardware is secure and tight.

In order to protect your bars/boards, please use mild soap/non-abrasive products for cleaning only.



Scan for
Installation Video

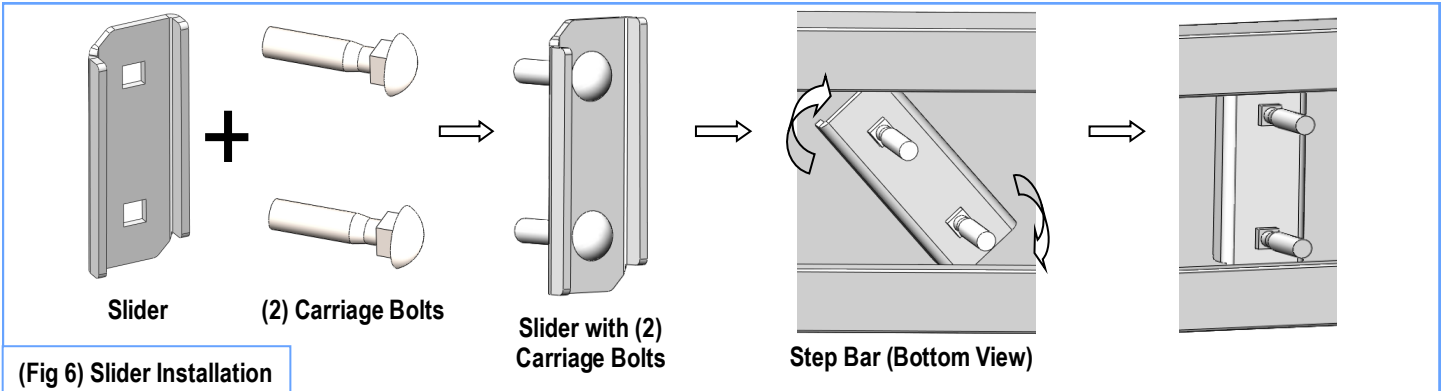

(Fig 6) Slider Installation

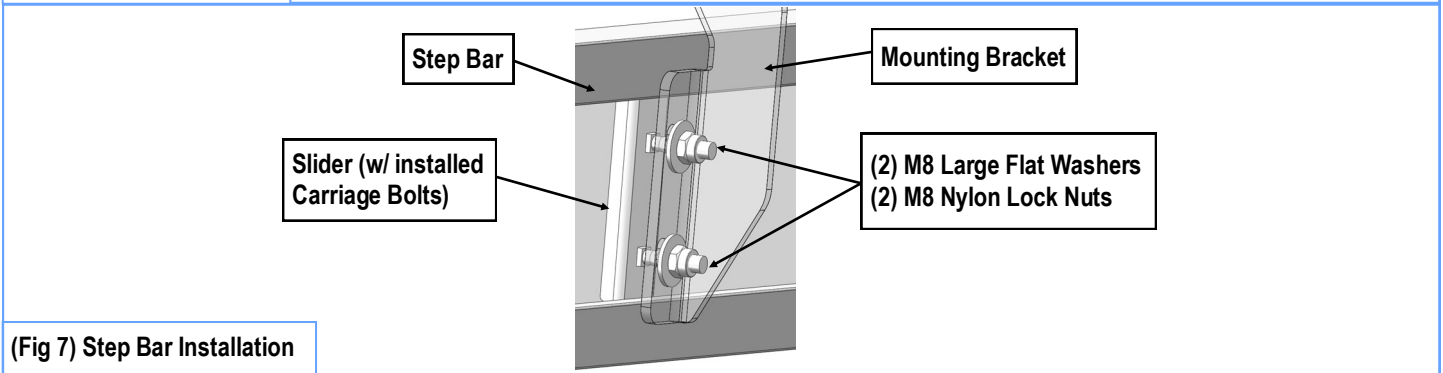

(Fig 7) Step Bar Installation

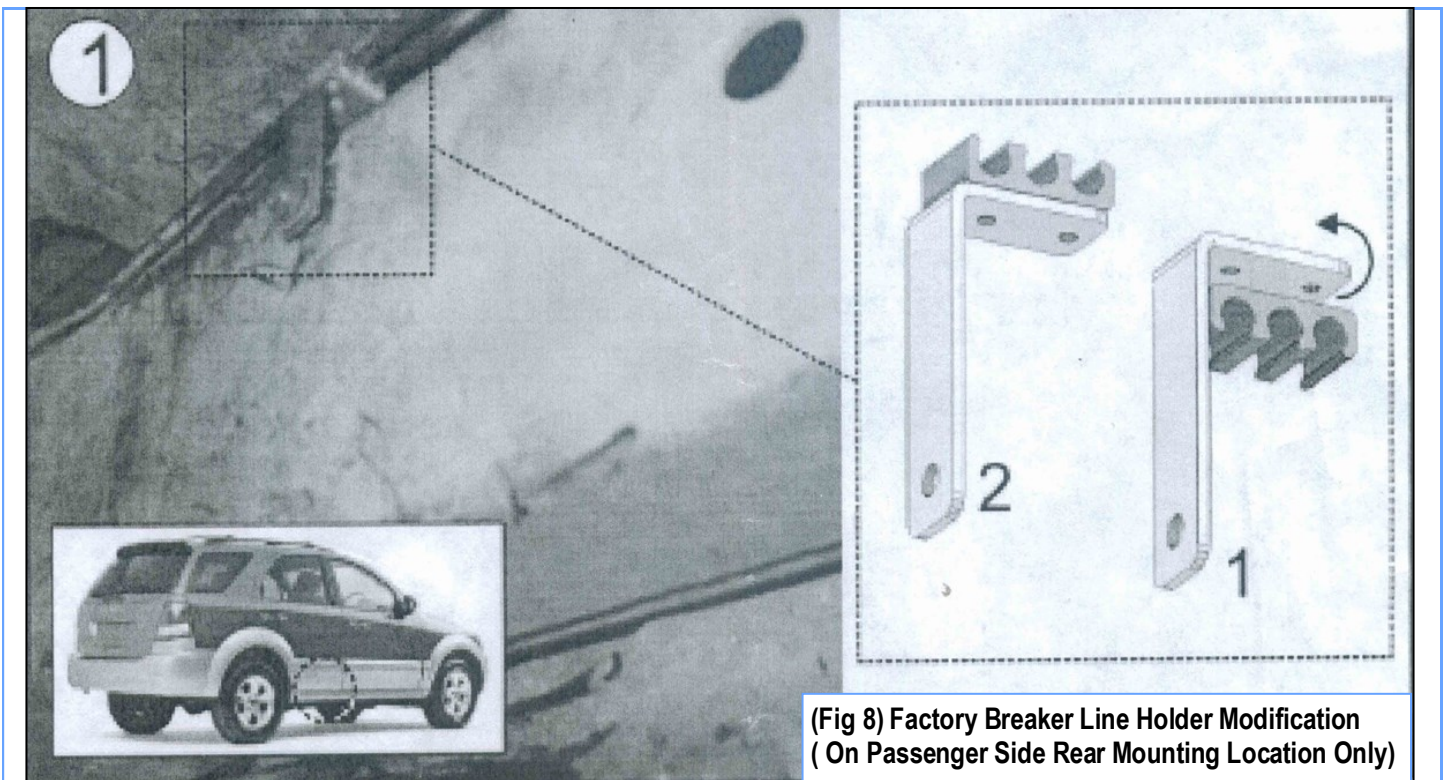

(Fig 8) Factory Breaker Line Holder Modification
(On Passenger Side Rear Mounting Location Only)