

# iBoard®



Scan for  
Installation Video

## iBoard® by APS

PART#: IB-P062Y&H

READ INSTRUCTIONS CAREFULLY BEFORE STARTING INSTALLATION. REMOVE CONTENTS FROM BOX AND VERIFY ALL PARTS ARE PRESENT. ASSISTANCE IS RECOMMENDED.

\*ROCKER PANEL MOUNT  
\*NO DRILLING REQUIRED

Fastener Size	Tightening Torque (ft-lbs)	Required
6mm	6-7	X
8mm	16-18	√
10mm	31-32	X
12mm	56-58	X
14mm	92-94	X

### PART LIST

#### Driver Side Step Bar



Front



#### Passenger Side Step Bar



Driver Front Mounting Bracket (DFM)

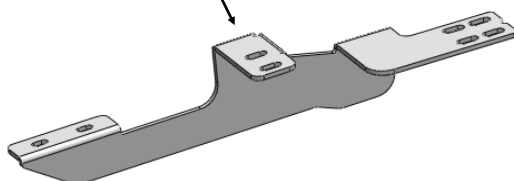

Passenger Front Mounting Bracket (PFM)

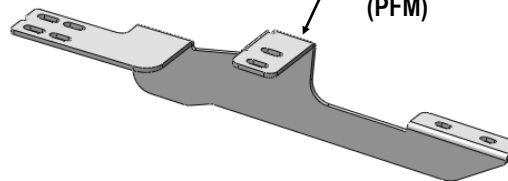

Driver Rear Mounting Bracket (DRM)

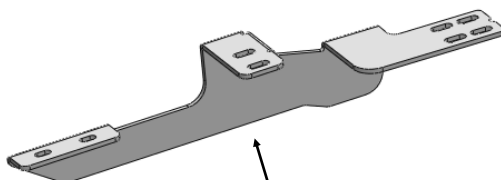

Passenger Rear Mounting Bracket (PRM)

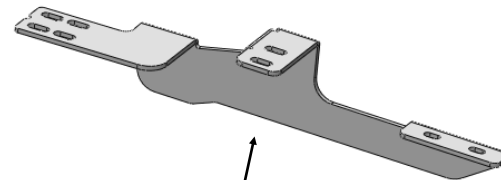

Customer Support: [info@iboardauto.com](mailto:info@iboardauto.com)



Scan for  
Installation Video

## Hardware Package A (For Bracket Installation)

Item	QTY	Description	Item	QTY	Description
1#	24	M8X1.25-35 Hex Bolts	3#	24	M8 Lock Washers
2#	24	M8 Flat Washers	4#	24	M8X1.25 Hex Nut

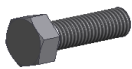

1 #



2 #



3 #



4 #

## Hardware Package B (For Step Bar Installation)

Item	QTY	Description	Item	QTY	Description
1#	8	M8X1.25-35mm Carriage Bolts	3#	8	M8 Nylon Lock Nuts
2#	8	M8 Large Flat Washers	4#	4	Sliders (Packed with Mounting Brackets)

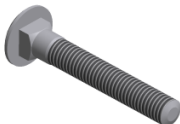

1 #



2 #



3 #

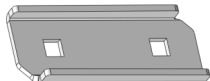

4 #



## STEP 1

Start installation from the driver side front of the vehicle. From underneath vehicle, place driver side front bracket in position as shown in (Fig 1).

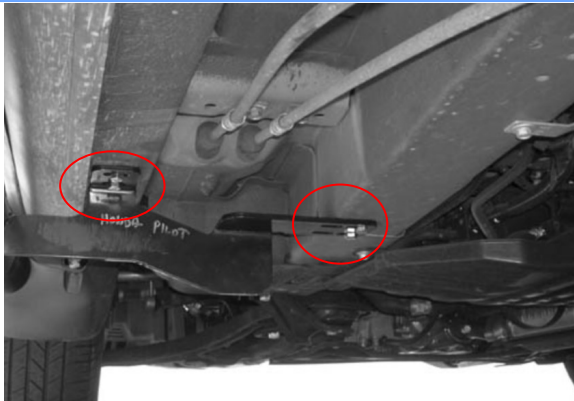

(Fig 1) Driver Side Front Mounting Location

## STEP 2

Attach Driver Front Mounting Bracket (**DFM**) to location with (6) M8x1.25-35mm Hex Bolts, (6) M8 Flat Washers, (6) M8 Lock Washers, (6) M8 Hex Nuts, (Fig 2). Do not fully tighten at this time.

Repeat for Driver Rear Mounting Bracket (**DRM**) installation (Fig 3).

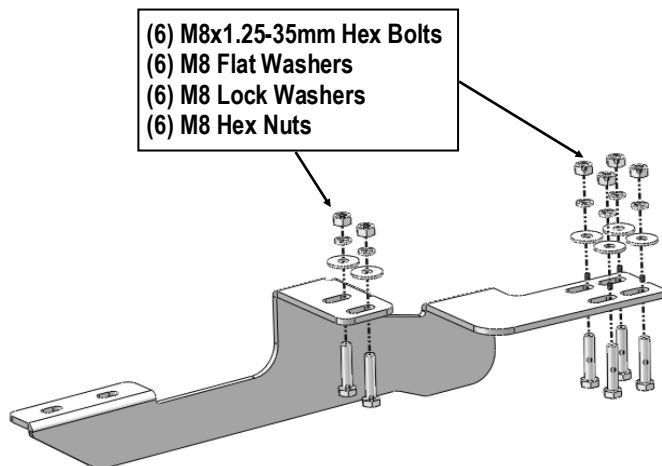

(Fig 2) Driver Front Mounting Bracket Installation

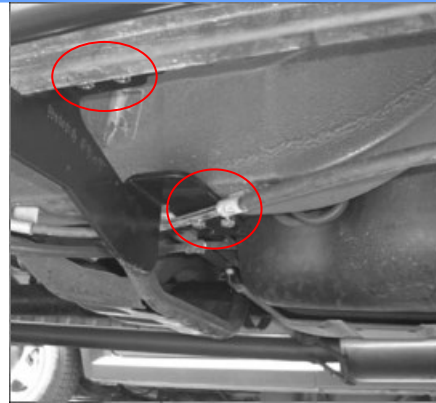

(Fig 3) Driver Rear Mounting Bracket Installed

## STEP 3

Once all (2) Driver side mounting brackets are installed, then proceed to the Step Bar installation. (Figs 4 & 5)

(1) Select (1) Slider and (2) M8X1.25-35mm Carriage Bolts;  
(2) Install (2) M8X1.25-35mm Carriage Bolts in (1) Slider.

(3) Slide the Slider (with carriage bolts) to the **Step Bar**.

(4) Repeat to install the other (1) slider to the step bar.

(5) Attach the Step Bar (with the Sliders) onto the installed mounting brackets. Position the Sliders to the installed brackets. Secure the Step Bar to the installed Brackets by using (4) M8 Large Flat Washers and (4) M8 Nylon Lock Nuts and (2) Sliders, (Fig 5). Do not fully tighten hardware at this time.

**Note:** The Sliders are packed with the Mounting Brackets.

Level and adjust the Step Bar and fully tighten all hardware.

Repeat **Steps 1-3** for the other side Step Bar installation. **The installation is completed!!!**

### Attention

**Do periodic inspections to the installation to make sure that all hardware is secure and tight.**

**In order to protect your bars/boards, please use mild soap/non-abrasive products for cleaning only.**

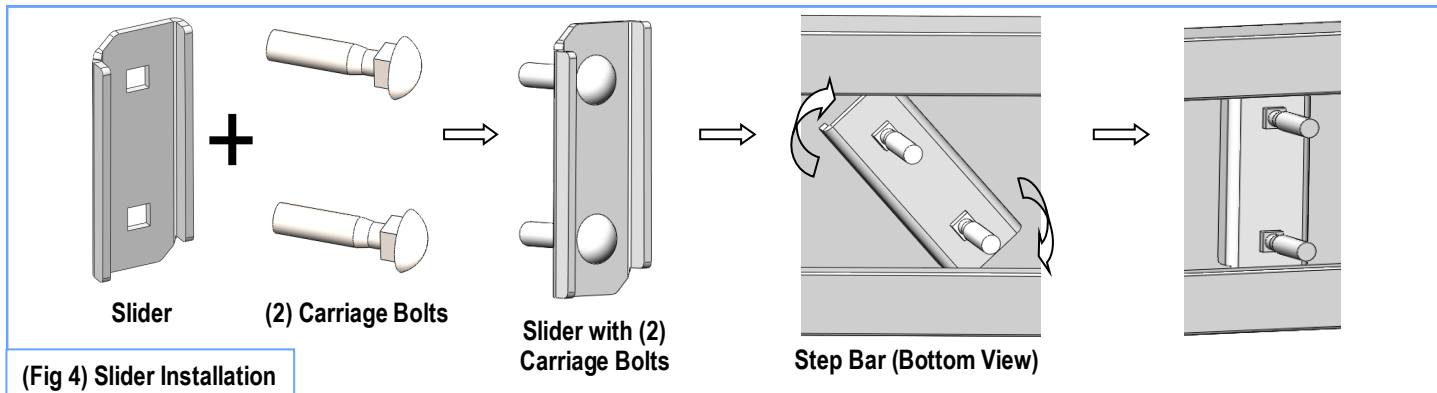

(Fig 4) Slider Installation

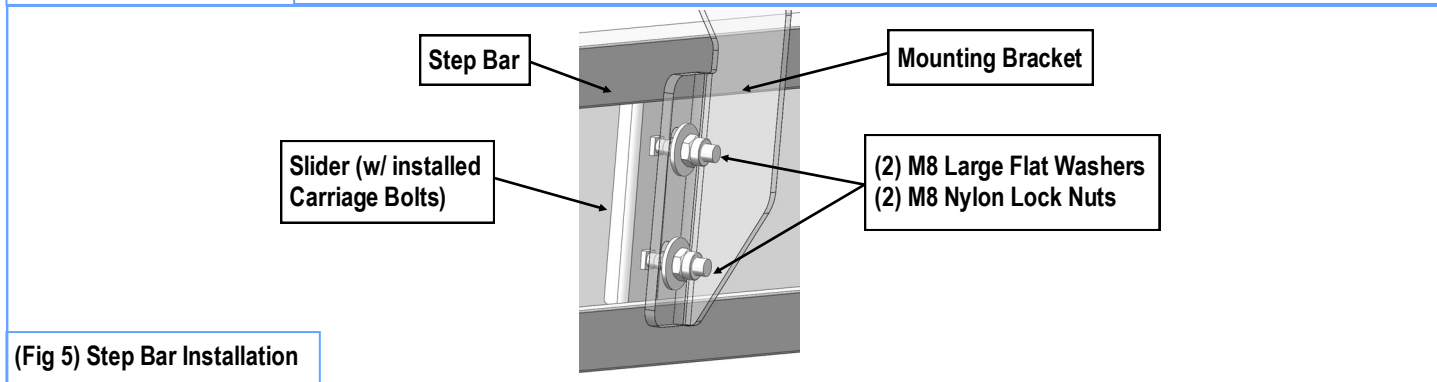

(Fig 5) Step Bar Installation