



Scan for
Installation Video

iBoard® Series

PART#: IB-P356Y&H

READ INSTRUCTIONS CAREFULLY BEFORE START ING INSTALLATION. REMOVE CONTENTS FROM BOX AND VERIFY ALL PARTS ARE PRESENT. ASSISTANCE IS RECOMMENDED.

*ROCKER PANEL MOUNT
*NO DRILLING REQUIRED

Fastener Size	Tightening Torque (ft-lbs)	Required
6mm	6-7	X
8mm	16-18	√
10mm	31-32	X
12mm	56-58	X
14mm	92-94	X

PART LIST

Driver Side Step Bar

Front
↑

Passenger Side Step Bar

Driver Front Mounting Bracket (DFM)

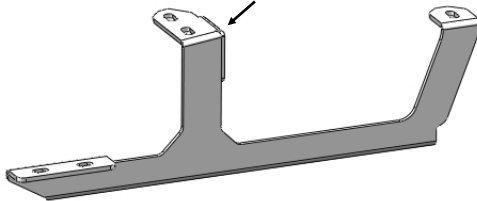

Passenger Front Mounting Bracket (PFM)

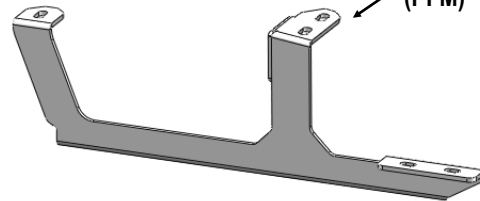

Driver Center Mounting Bracket (DCM)

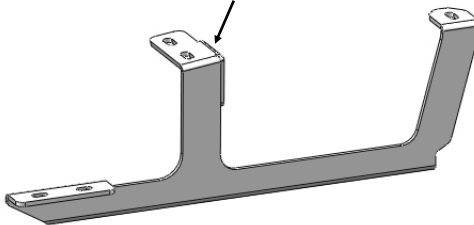

Passenger Center Mounting Bracket (PCM)

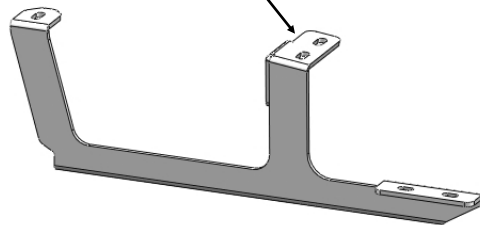

Driver Rear Mounting Bracket (DRM)

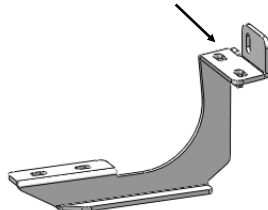

Passenger Rear Mounting Bracket (PRM)

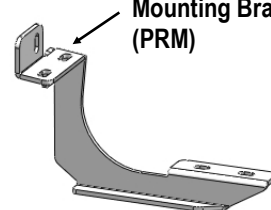



Scan for
Installation Video

Hardware Package A (For Bracket Installation)					
Item	QTY	Description	Item	QTY	Description
1#	18	M8X1.25-25mm Hex Bolts	3#	18	M8 Lock Washers
2#	18	M8 Large Flat Washers			

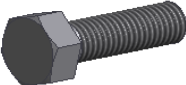

1#



2#



3#

Hardware Package B (For Step Bar Installation)					
Item	QTY	Description	Item	QTY	Description
1#	12	M8X1.25-35mm Carriage Bolts	3#	12	M8 Nylon Lock Nuts
2#	12	M8 Large Flat Washers	4#	6	Sliders (Packed with Mounting Brackets)

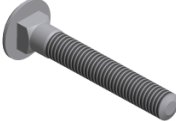

1 #



2 #



3 #

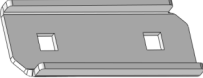

4 #



STEP 1

Starting installation under the driver side of the vehicle. Remove the plastic cover under the driver side of the vehicle, (Fig 1).



(Fig 1) Driver Side Front Mounting Location

STEP 2

Select the Driver Front Mounting Bracket (DFM). Attach the outer end of the Driver Front Mounting Bracket to the (2) threaded holes next to the pinch weld with the included (2) M8X1.25-25mm Hex Bolts, (2) M8 Large Flat Washers and (2) M8 Lock Washers, (Fig 2).

Attach the inner tab on the bracket to the threaded hole in the bottom of the inner frame channel with the included (1) M8X1.25-25mm Hex Bolt, (1) M8 Large Flat Washer and (1) M8 Lock Washer, (Fig 2). Do not fully tighten hardware at this time.

IMPORTANT: The Front and Center Mounting Brackets are similar but not the same.

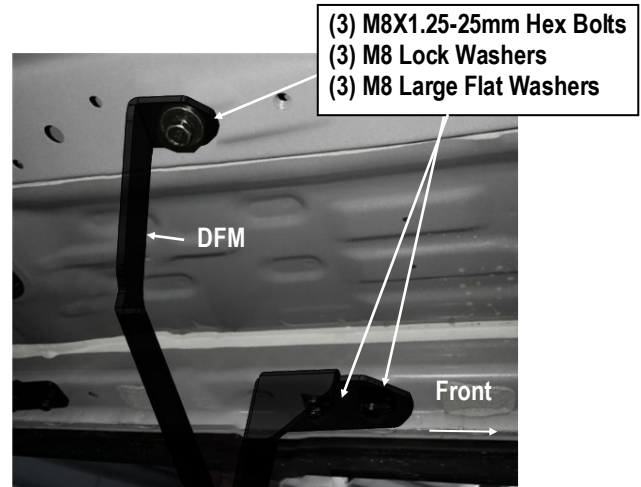

(Fig 2) Driver Front Mounting Bracket Installed

STEP 3

Move to the driver side center of the vehicle and repeat **Steps 1-2** for the Driver Center Mounting Bracket installation, (Fig 4).

NOTE: On some models, the mounting holes are covered by sealant or undercoating. It is required to scrap off the sealant and undercoating carefully before installing the Driver Center Mounting Bracket, (Fig 3).

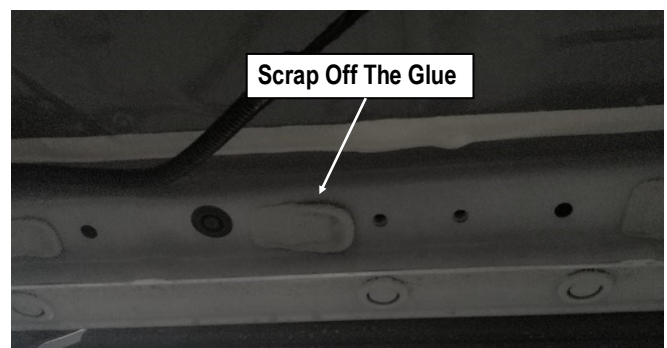

(Fig 3) Driver Side Center Mounting Location

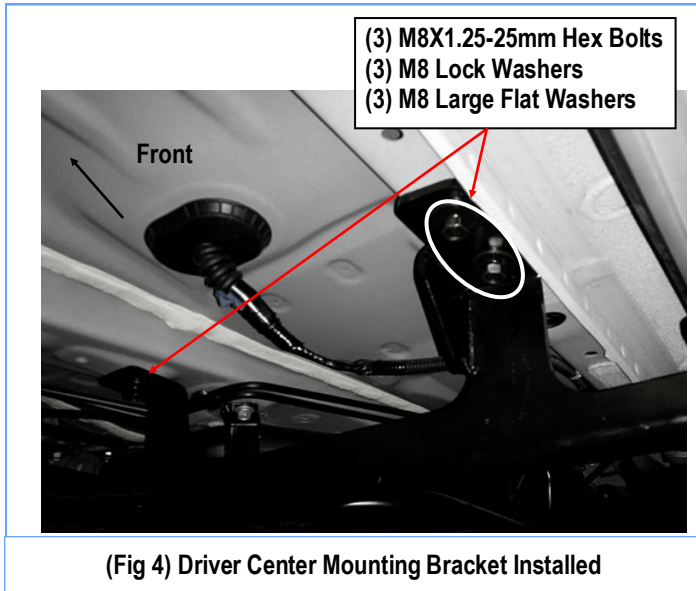

(Fig 4) Driver Center Mounting Bracket Installed

STEP 4

Move to the driver side center of the vehicle and repeat **Steps 1-2** for the Driver Center Mounting Bracket installation, (Fig 4).

NOTE: On some models, the mounting holes are covered by sealant or undercoating. It is required to scrap off the sealant and undercoating carefully before installing the Driver Center Mounting Bracket, (Fig 3).

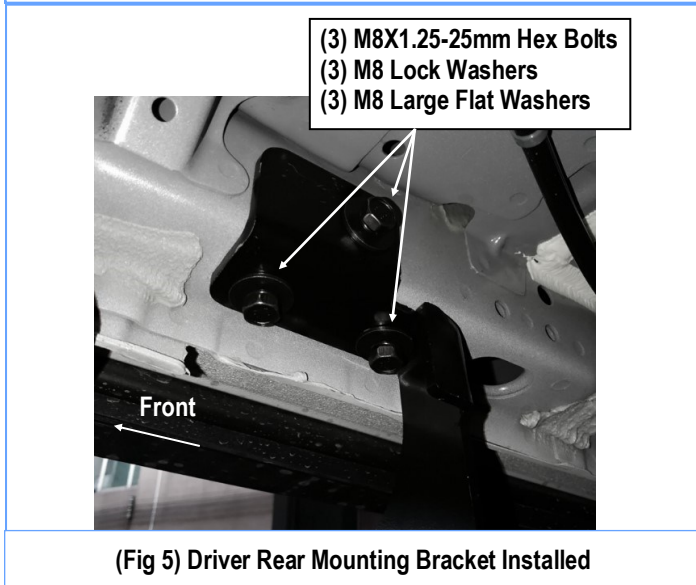

(Fig 5) Driver Rear Mounting Bracket Installed

STEP 5

Once all (3) Driver side mounting brackets are installed, then proceed to the Step Bar installation. (Figs 6 & 7)

- (1) Select (1) Slider and (2) M8X1.25-35mm Carriage Bolts;
- (2) Install (2) M8X1.25-35mm Carriage Bolts in (1) Slider.
- (3) Slide the Slider (with carriage bolts) to the **Step Bar**.
- (4) Repeat to install the other (2) sliders to the step bar.
- (5) Attach the Step Bar (with the Sliders) onto the installed mounting brackets. Position the Sliders to the installed brackets. Secure the Step Bar to the installed Brackets by using (6) M8 Large Flat Washers and (6) M8 Nylon Lock Nuts and (3) Sliders, (Fig 7). Do not fully tighten hardware at this time.

Note: The Sliders are packed with the Mounting Brackets.

Level and adjust the Step Bar and fully tighten all hardware.

Repeat **Steps 1-5** for the other side Step Bar installation. **The installation is completed!!!**

Attention

Do periodic inspections to the installation to make sure that all hardware is secure and tight.

In order to protect your bars/boards, please use mild soap/non-abrasive products for cleaning only.

