



PART#: IB-P926Y&H

iBoard® Series

READ INSTRUCTIONS CAREFULLY BEFORE START ING INSTALLATION. REMOVE CONTENTS FROM BOX AND VERIFY ALL PARTS ARE PRESENT. ASSISTANCE IS RECOMMENDED.

Fastener Size	Tightening Torque (ft-lbs)	Required
6mm	6-7	X
8mm	16-18	√
10mm	31-32	√
12mm	56-58	X
14mm	92-94	X

*ROCKER PANEL MOUNT
*NO DRILLING REQUIRED

PART LIST

Driver Side Step Bar



Front



Passenger Side Step Bar

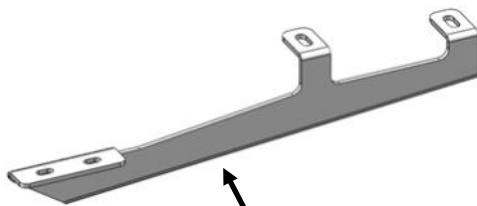

Driver Front Mounting Bracket (DFM)

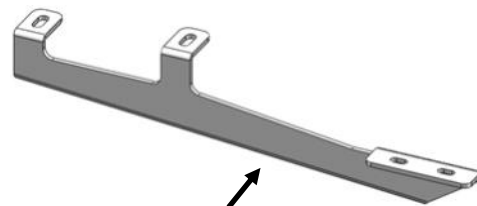

Passenger Front Mounting Bracket (PFM)

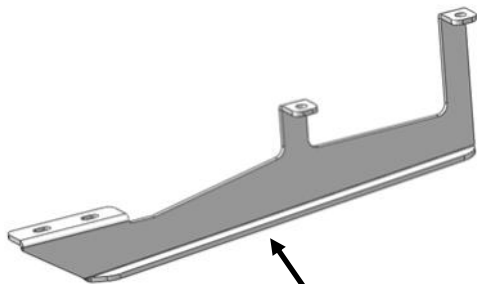

Driver Rear Mounting Bracket (DRM)

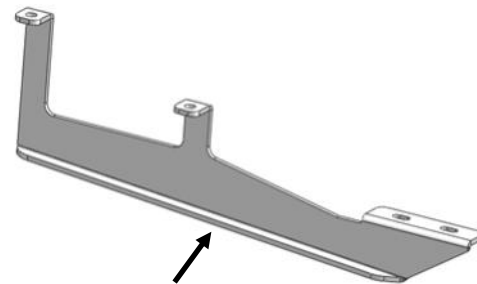



Passenger Rear Mounting Bracket (PRM)





Scan for
Installation Video

Hardware Package A (For Bracket Installation)					
Item	QTY	Description	Item	QTY	Description
1#	2	M10X1.5-30 Bolt Plates	4#	4	M10 Flat Washers
2#	4	M10 Plastic Washers	5#	4	M10 Lock Washers
3#	2	M10X1.5 J-Bolts	6#	4	M10 Hex Nuts



1#

2#



3#



4#



5#



6#

Hardware Package B (For Step Bar Installation)					
Item	QTY	Description	Item	QTY	Description
1#	8	M8X1.25-35mm Carriage Bolts	3#	8	M8 Nylon Lock Nuts
2#	8	M8 Large Flat Washers	4#	4	Sliders (Packed with Mounting Brackets)

1 #

2 #

3 #

4 #



STEP 1

Starting installation from the Driver side front of the vehicle. Remove the Plastic cover under the body floor if equipped, (**Fig 1**).

Insert (1) M10 Bolt Plate into inner hole, and use a M10 Plastic Washer to hold in place. Insert (1) M10 T-Bolt into outer hole and use a M10 Plastic Washer to hold in place, (**Fig 2**).

NOTE: The Plastic Washer is designed to keep the Bolt Plate & J-Bolt from falling into the body panel during bracket installation.

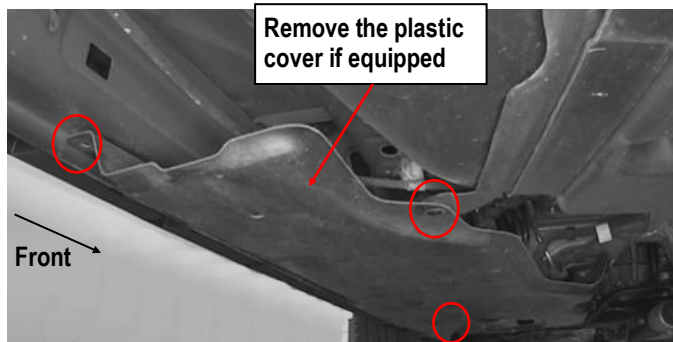

(Fig 1) Remove the plastic cover if equipped
(On Driver Side Front Mounting Location)

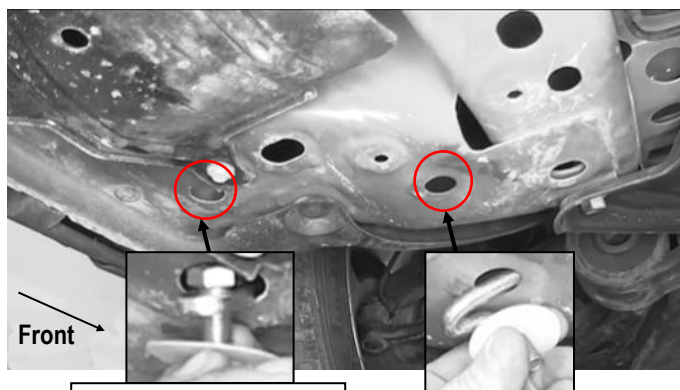

Insert (1) M10 T-Bolt
with M10 plastic washer

Insert (1) M10 J-Bolt with
M10 plastic washer

(Fig 2) Driver Side Front Mounting Location

STEP 2

Attach Driver Front Mounting Bracket (**DFM**) to the installed M10 J-Bolt and M10 T-Bolt with (2) M10 Flat Washers, (2) M10 Lock Washers and (2) M10 Hex Nuts, (**Figs 3&4**). Do not fully tighten at this time.

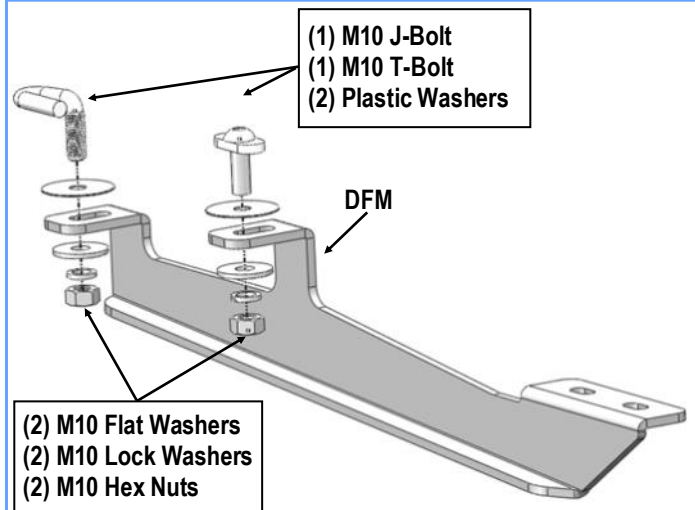

(Fig 3) Driver Front Mounting Bracket Installation

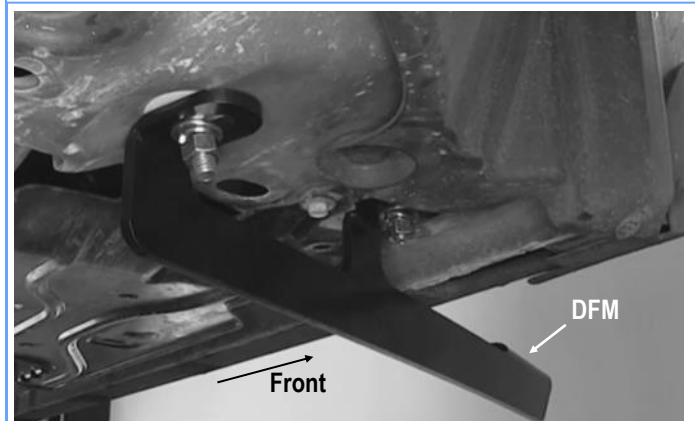

(Fig 4) Driver Front Mounting Bracket Installed

STEP 3

Move to the Driver Side Rear Mounting Location. Remove the (2) factory bolts from the rear suspension bracket, (**Fig 5**). Slide bracket into place and secure reusing factory bolts, (**Fig 6**). Don't fully tighten at this time.

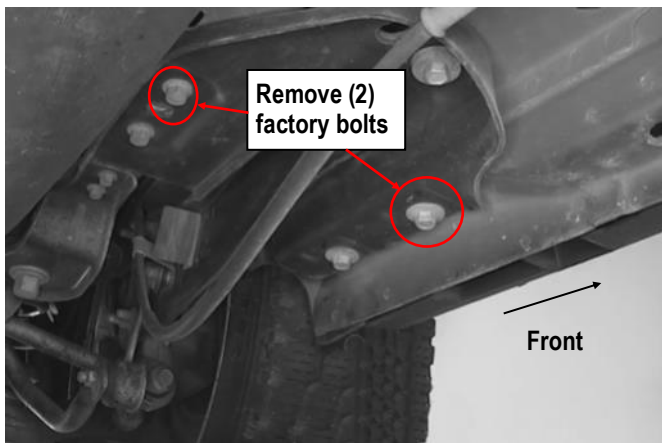

(Fig 5) Driver Side Rear Mounting Location

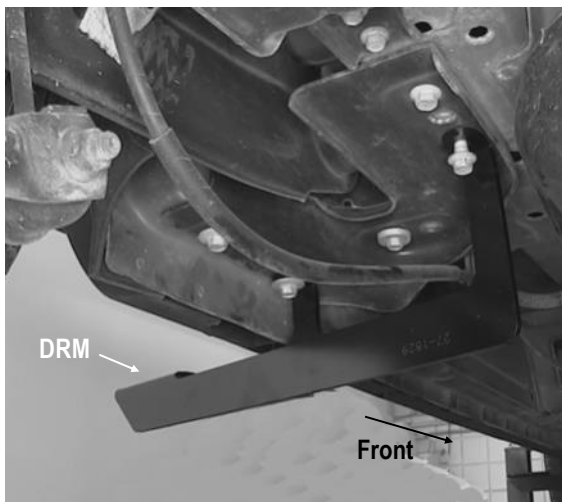

(Fig 6) Driver Rear Mounting Bracket Installed

STEP 4

Once all (2) Driver side mounting brackets are installed, then proceed to the Step Bar installation. (Figs 7 & 8)

(1) Select (1) Slider and (2) M8X1.25-35mm Carriage Bolts;

(2) Install (2) M8X1.25-35mm Carriage Bolts in (1) Slider.

(3) Slide the Slider (with carriage bolts) to the **Step Bar**.

(4) Repeat to install the other (1) slider to the step bar.

(5) Attach the Step Bar (with the Sliders) onto the installed mounting brackets. Position the Sliders to the installed brackets. Secure the Step Bar to the installed Brackets by using (4) M8 Large Flat Washers and (4) M8 Nylon Lock Nuts and (2) Sliders, (Fig 8). Do not fully tighten hardware at this time.

Note: The Sliders are packed with the Mounting Brackets.

Level and adjust the Step Bar and fully tighten all hardware.

Repeat **Steps 1-4** for the other side Step Bar installation. **The installation is completed!!!**

Attention

Do periodic inspections to the installation to make sure that all hardware is secure and tight.

In order to protect your bars/boards, please use mild soap/non-abrasive products for cleaning only.

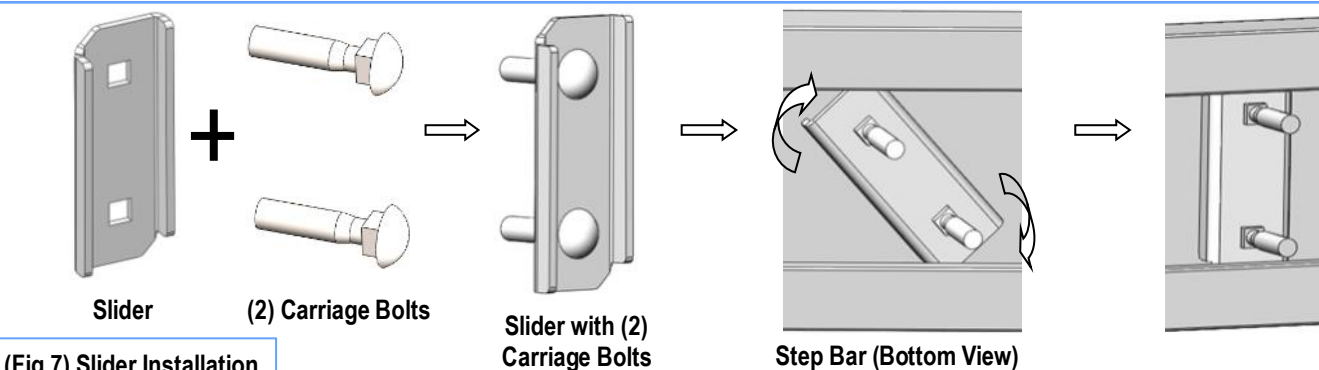

(Fig 7) Slider Installation

