

iBoard®



Scan for
Installation Video

iBoard® by APS

PART#: IB-P925Y&H

READ INSTRUCTIONS CAREFULLY BEFORE STARTING INSTALLATION. REMOVE CONTENTS FROM BOX AND VERIFY ALL PARTS ARE PRESENT. ASSISTANCE IS RECOMMENDED.

*ROCKER PANEL MOUNT
*NO DRILLING REQUIRED

Fastener Size	Tightening Torque (ft-lbs)	Required
6mm	6-7	X
8mm	16-18	√
10mm	31-32	X
12mm	56-58	X
14mm	92-94	X

PART LIST

Driver Side Step Bar

Front

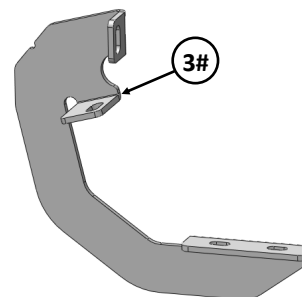
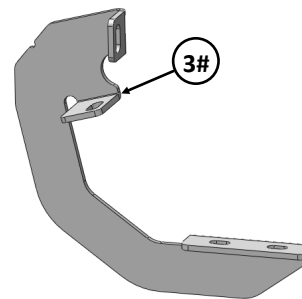
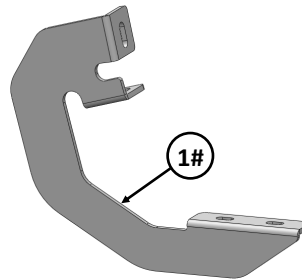
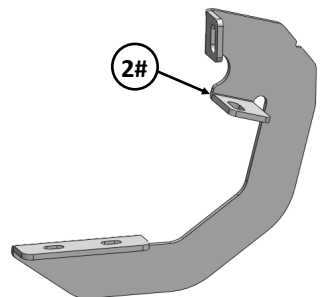
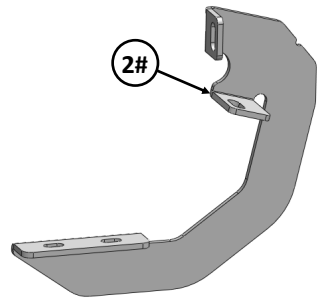
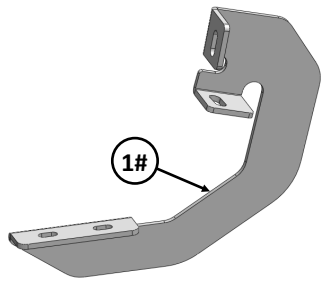
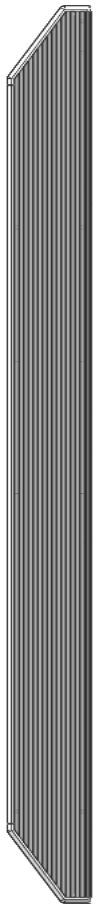

Passenger Side Step Bar







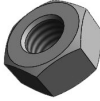
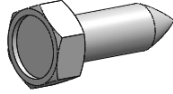

Scan for
Installation Video

Hardware Package A (For Bracket Installation)					
Item	QTY	Description	Item	QTY	Description
1#	2	Driver/Passenger Front Mounting Brackets	5#	18	M8 Large Flat Washers
2#	2	Driver Center/Rear Mounting Brackets	6#	12	M8 Lock Washers
3#	2	Passenger Center/Rear Mounting Brackets	7#	6	M8 Hex Nuts
4#	12	M8X1.25-25mm Hex Bolts	8#	6	ST8x25mm Hex Self Tapping Screws

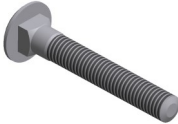
				
4#	5#	6#	7#	8#

Hardware Package B (For Step Bar Installation)					
Item	QTY	Description	Item	QTY	Description
1#	12	M8X1.25-35mm Carriage Bolts	3#	12	M8 Nylon Lock Nuts
2#	12	M8 Large Flat Washers	4#	6	Sliders (Packed with Mounting Brackets)

			
1#	2#	3#	4#



STEP 1

Start installation from the passenger side of the vehicle. Locate Passenger Side mounting locations. Remove any tape on the inside of rocker panel that covers the mounting holes. **NOTE:** (1) ST8x25mm Hex Self Tapping Screw replace (1) M8 bolt per bracket if the factory holes are not tapped for M8 bolts.

STEP 2

Attach the Passenger Side Mounting Brackets to the body panel as shown, (Fig 1). Do not fully tighten hardware at this time.

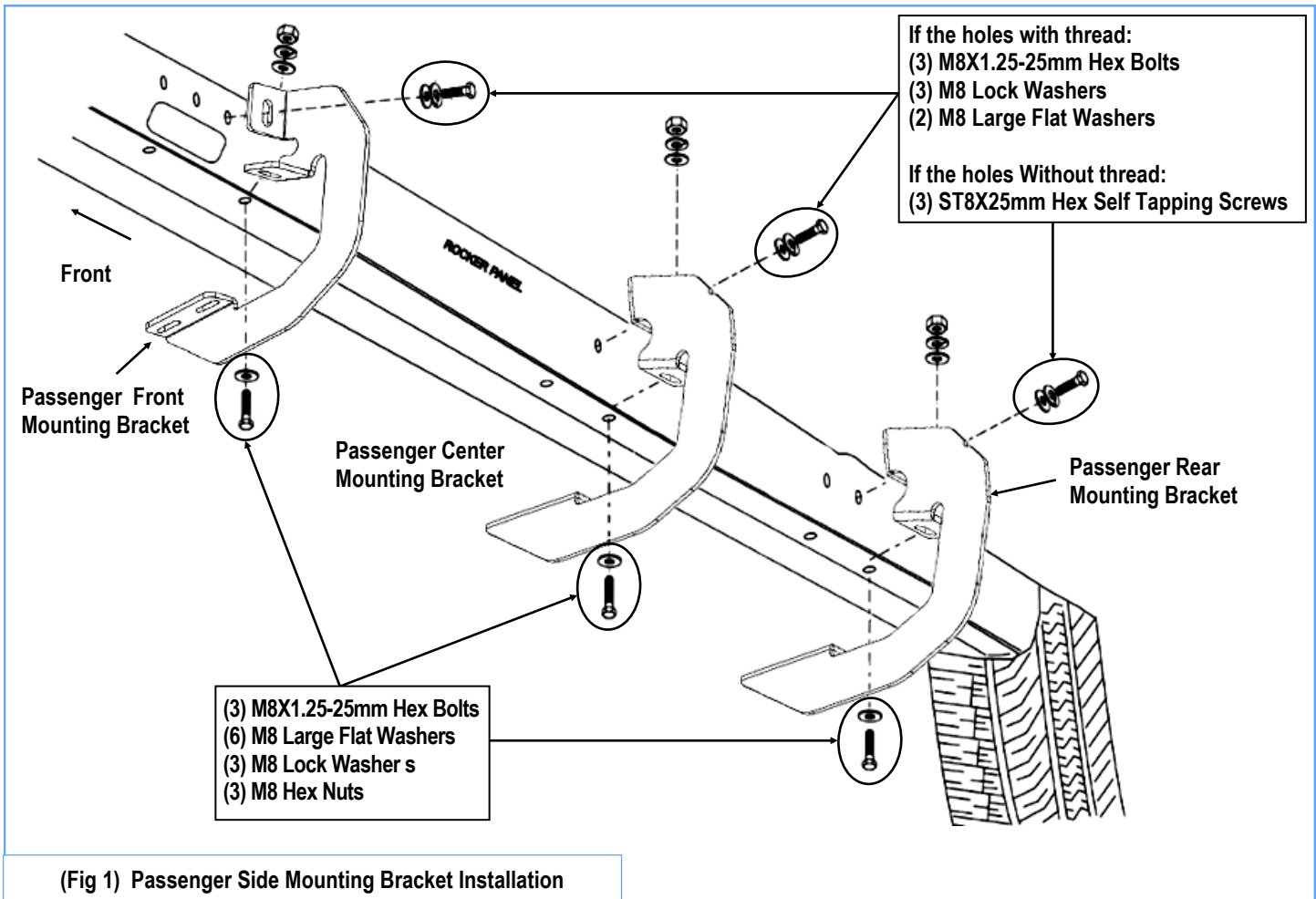



STEP 3

Once all (3) Passenger side mounting brackets are assembled, then proceed to the Step Bar installation. (**Figs 2 & 3**)

(1) Select (1) Slider and (2) M8X1.25-35mm Carriage Bolts;

(2) Install (2) M8X1.25-35mm Carriage Bolts in (1) Slider.

(3) Slide the Slider (with carriage bolts) to the **Step Bar**.

(4) Repeat to install the other (2) sliders to the step bar.

(5) Attach the Step Bar (with the Sliders) onto the installed mounting brackets. Position the Sliders to the installed brackets. Secure the Step Bar to the installed Brackets by using (6) M8 Large Flat Washers and (6) M8 Nylon Lock Nuts and (3) Sliders, (**Fig 3**). Do not fully tighten hardware at this time.

Note: The Sliders are packed with the Mounting Brackets.

Level and adjust the Step Bar and fully tighten all hardware.

Repeat **Steps 1-3** for the other side Step Bar installation. **The installation is completed!!!**

Attention

Do periodic inspections to the installation to make sure that all hardware is secure and tight.

In order to protect your bars/boards, please use mild soap/non-abrasive products for cleaning only.

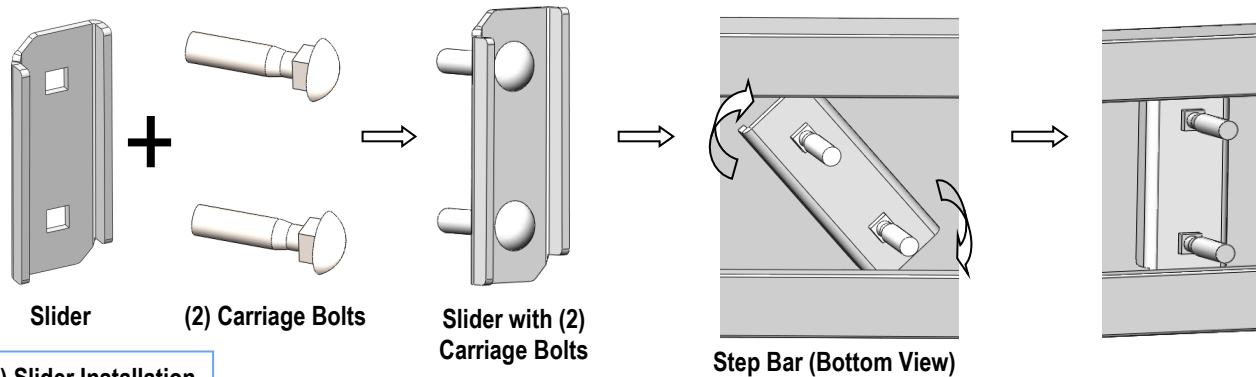

(Fig 2) Slider Installation

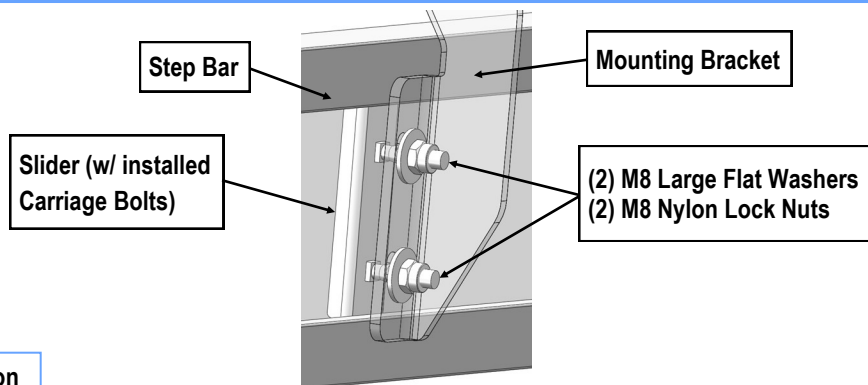

(Fig 3) Step Bar Installation