

# iBoard®



Scan for  
Installation Video

## iBoard® by APS

PART#: IB-P552Y&H

READ INSTRUCTIONS CAREFULLY BEFORE STARTING INSTALLATION. REMOVE CONTENTS FROM BOX AND VERIFY ALL PARTS ARE PRESENT. ASSISTANCE IS RECOMMENDED.

\*ROCKER PANEL MOUNT  
\*NO DRILLING REQUIRED

Fastener Size	Tightening Torque (ft-lbs)	Required
6mm	6-7	X
8mm	16-18	√
10mm	31-32	√
12mm	56-58	X
14mm	92-94	X

### PART LIST

#### Driver Side Step Bar

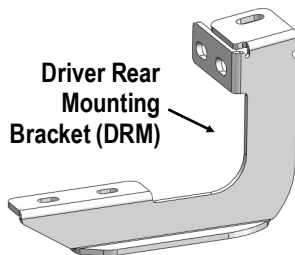
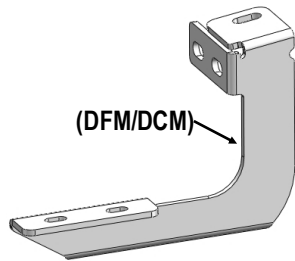
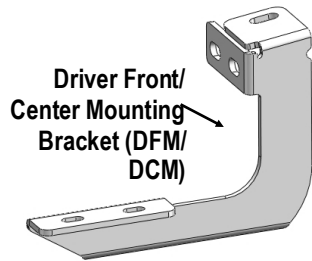

Front



#### Passenger Side Step Bar

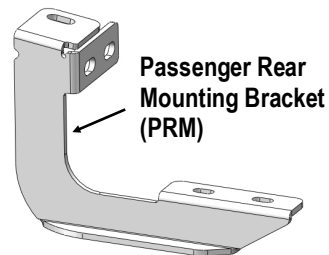
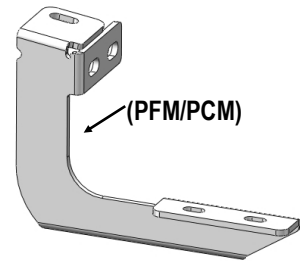
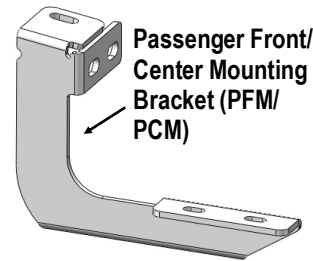







Customer Support: [info@iboardauto.com](mailto:info@iboardauto.com)

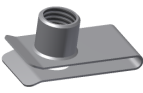
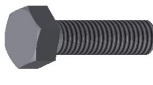

## Hardware Package A (For Bracket Installation)

Item	QTY	Description	Item	QTY	Description
1#	6	M10X1.5-30mm Hex Bolts	5#	12	M8X1.25-25mm Hex Bolts
2#	6	M10 Large Flat Washers	6#	24	M8 Large Flat Washers
3#	6	M10 Lock Washers	7#	12	M8 Lock Washers
4#	6	M10 Clip Nuts	8#	12	M8 Hex Nuts





  

							
1 #	2 #	3 #	4 #	5 #	6 #	7 #	8 #

## Hardware Package B (For Step Bar Installation)

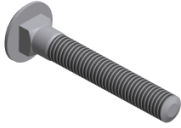
Item	QTY	Description	Item	QTY	Description
1#	12	M8X1.25-35mm Carriage Bolts	3#	12	M8 Nylon Lock Nuts
2#	12	M8 Large Flat Washers	4#	6	Sliders (Packed with Mounting Brackets)

  

			
1 #	2 #	3 #	4 #



## STEP 1

Start installation from the passenger side front of the vehicle, temporarily remove the plastic side panel. Move to the floor panel, locate the square hole and (2) round holes in the pinch weld, (Fig 1).

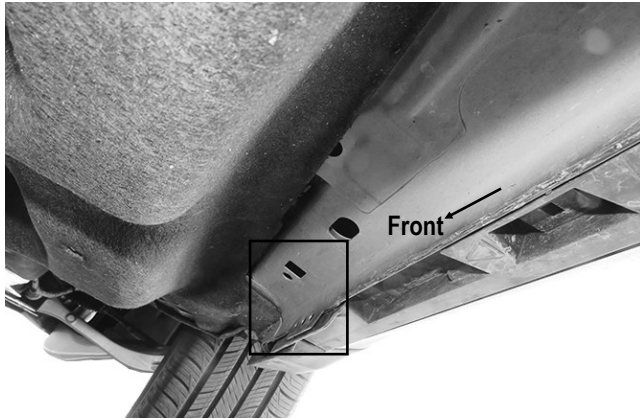

(Fig 1) Passenger Side Front Mounting Location

## STEP 2

Insert (1) M10 Clip Nut into the square hole on the floor panel, and line up the nut with the round hole, (Fig 2).

Attach (1) Passenger Front Mounting Bracket to the installed M10 Clip Nut with (1) M10X1.5-30mm Hex Bolt, (1) M10 Lock Washer and (1) M10 Flat Washer, (Figs 3-4). Do not fully tighten hardware at this time.

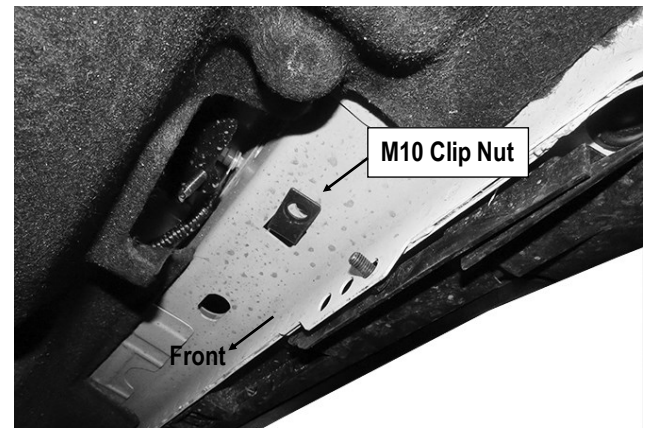

(Fig 2) Attach The M10 Clip Nut

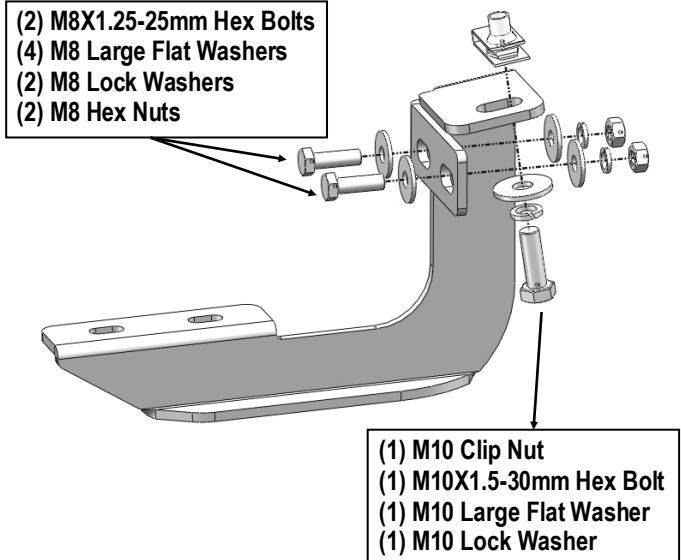

(Fig 3) Passenger Front Mounting Bracket Installation

## STEP 3

Attach the Passenger Front Mounting Bracket to the pinch weld with (2) M8X1.25-25mm Hex Bolts, (4) M8 Flat Washers, (2) M8 Lock Washers and (2) M8 Hex Bolts, (Figs 3-4). Do not fully tighten hardware at this time.



(Fig 4) Passenger Front Mounting Bracket Installation



## STEP 4

Move to the Passenger Side Center & Rear Mounting Locations, (**Fig 5 & 6**). Repeat **Steps 1-3** to attach the Passenger Center & Rear Mounting Brackets to the vehicle. Do not fully tighten hardware at this time.

**Note:** (3) Passenger Front & Center & Rear Mounting Brackets are universal.

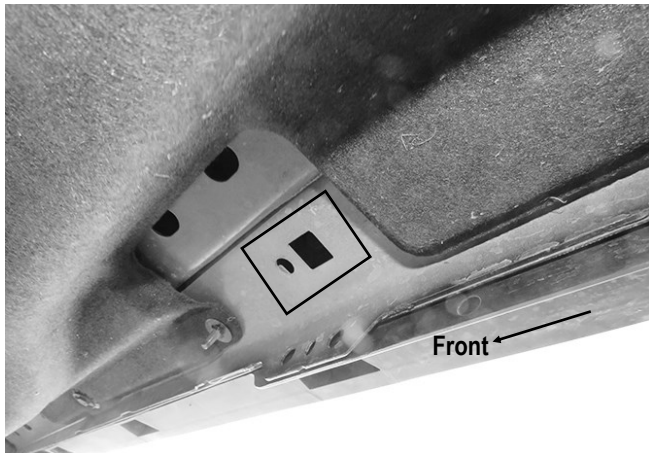

(Fig 5) Passenger Side Center Mounting Location

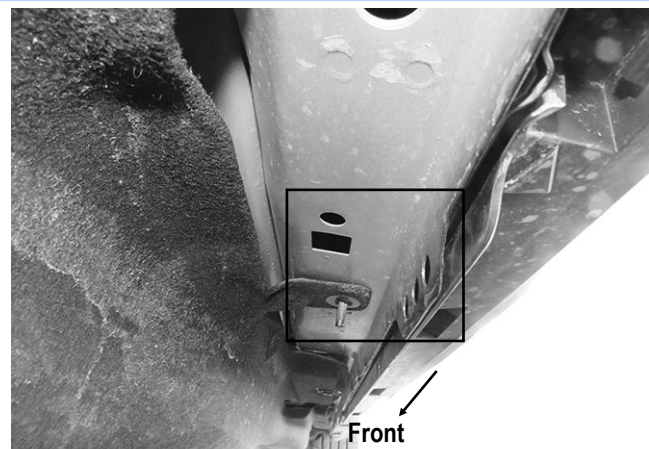

(Fig 6) Passenger Side Rear Mounting Location

## STEP 5

Once all (3) Passenger side mounting brackets are installed, then proceed to the Step Bar installation. (**Figs 7 & 8**)

(1) Select (1) Slider and (2) M8X1.25-35mm Carriage Bolts;

(2) Install (2) M8X1.25-35mm Carriage Bolts in (1) Slider.

(3) Slide the Slider (with carriage bolts) to the **Step Bar**.

(4) Repeat to install the other (2) sliders to the step bar.

(5) Attach the Step Bar (with the Sliders) onto the installed mounting brackets. Position the Sliders to the installed brackets. Secure the Step Bar to the installed Brackets by using (6) M8 Large Flat Washers and (6) M8 Nylon Lock Nuts and (3) Sliders, (**Fig 8**). Do not fully tighten hardware at this time.

**Note:** The Sliders are packed with the Mounting Brackets.

Level and adjust the Step Bar and fully tighten all hardware.

Repeat **Steps 1-5** for the other side Step Bar installation. **The installation is completed!!!**

### Attention

**Do periodic inspections to the installation to make sure that all hardware is secure and tight.**

**In order to protect your bars/boards, please use mild soap/non-abrasive products for cleaning only.**



Scan for  
Installation Video

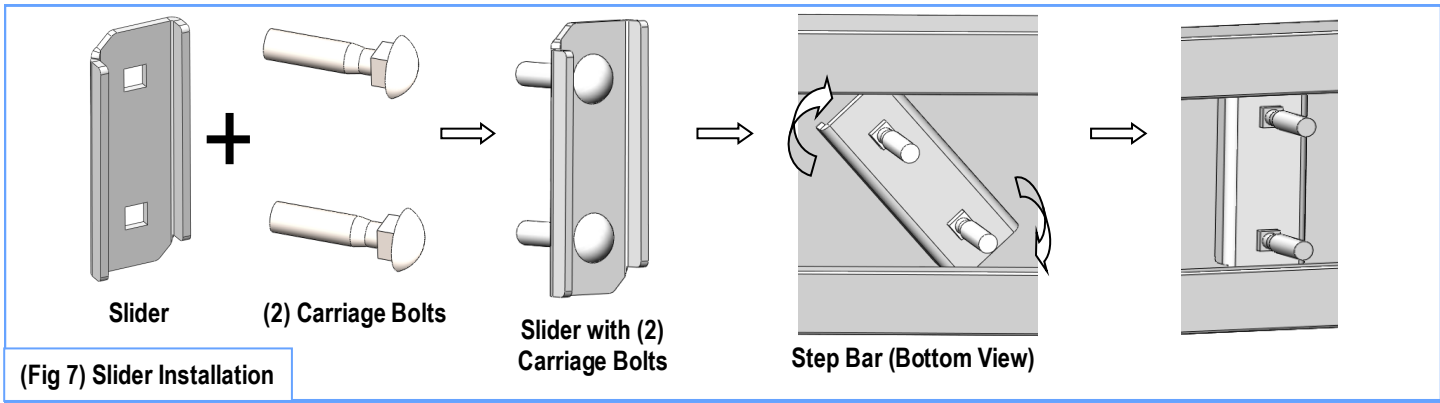

(Fig 7) Slider Installation

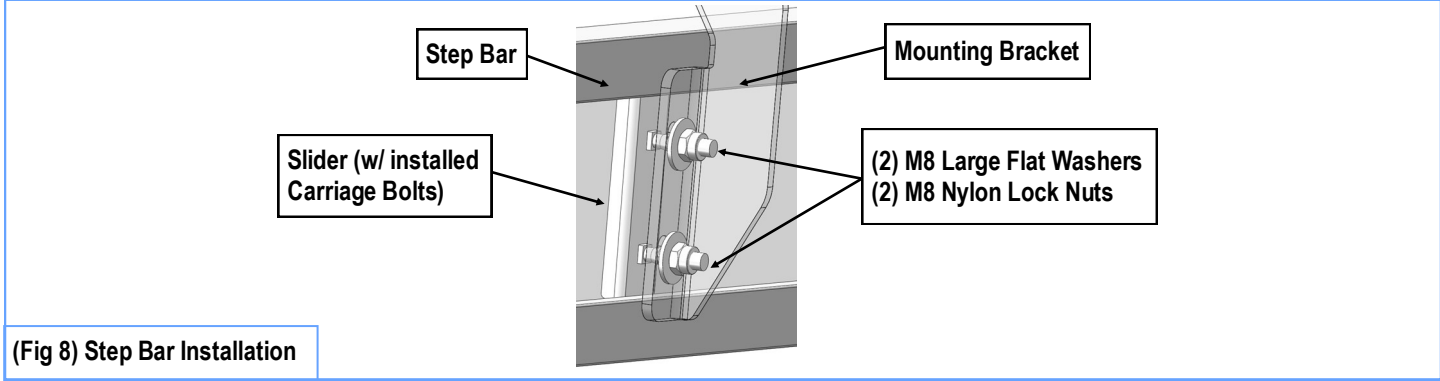

(Fig 8) Step Bar Installation