

# iBoard®



Scan for  
Installation Video

## iBoard® by APS

PART#: IB-P234Y&H

READ INSTRUCTIONS CAREFULLY BEFORE STARTING INSTALLATION. REMOVE CONTENTS FROM BOX AND VERIFY ALL PARTS ARE PRESENT. ASSISTANCE IS RECOMMENDED.

\*ROCKER PANEL MOUNT  
\*NO DRILLING REQUIRED

Fastener Size	Tightening Torque (ft-lbs)	Required
6mm	6-7	X
8mm	16-18	√
10mm	31-32	X
12mm	56-58	X
14mm	92-94	X

### PART LIST

#### Driver Side Step Bar

Front  
↑

#### Passenger Side Step Bar



Driver Front Mounting Bracket (DFM)

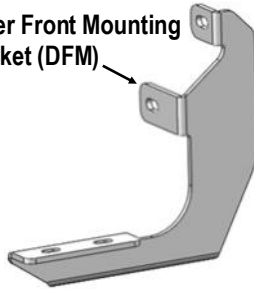

Driver Center/Rear Mounting Bracket (DCM/DRM)

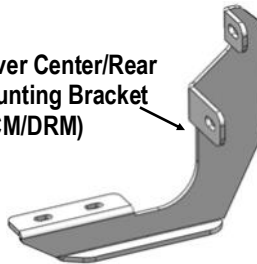

(DCM/DRM)

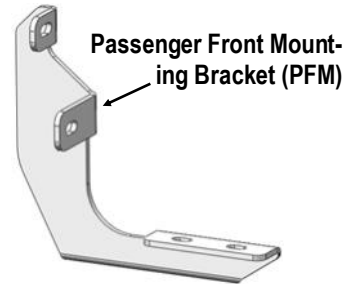
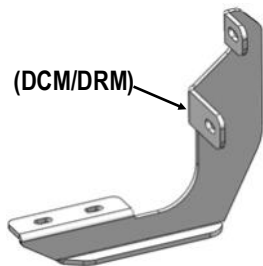

Passenger Front Mounting Bracket (PFM)

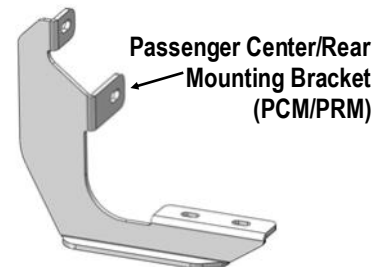

Passenger Center/Rear Mounting Bracket (PCM/PRM)

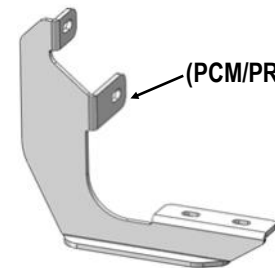

(PCM/PRM)



Customer Support: [info@iboardauto.com](mailto:info@iboardauto.com)



Scan for  
Installation Video

Hardware Package A (For Bracket Installation)					
Item	QTY	Description	Item	QTY	Description
1#	12	M8 Plastic Washers	3#	12	M8 Nylon Lock Nuts
2#	12	M8 Flat Washers			



1 #



2 #



3 #

Hardware Package B (For Step Bar Installation)					
Item	QTY	Description	Item	QTY	Description
1#	12	M8X1.25-35mm Carriage Bolts	3#	12	M8 Nylon Lock Nuts
2#	12	M8 Large Flat Washers	4#	6	Sliders (Packed with Mounting Brackets)



1 #



2 #



3 #



4 #



## STEP 1

Start installation from the passenger side front of the vehicle. Locate the Passenger Side Front Mounting Location along the inner side of the body panel, (Fig 1).

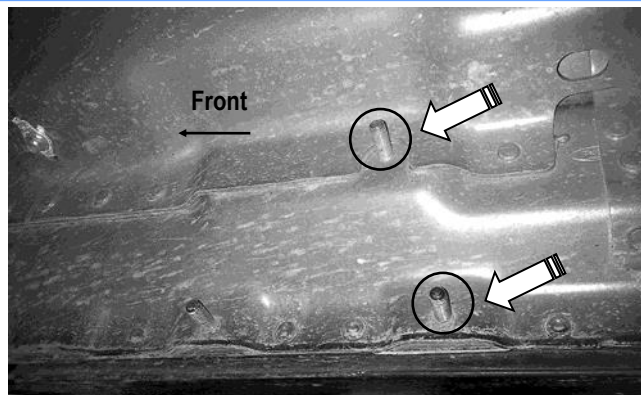

(Fig 1) Passenger Side Front Mounting Location

## STEP 2

Thread (2) M8 Plastic Washers over the (2) factory mounting studs on the body panel, (Fig 2).

**IMPORTANT:** The M8 Plastic Washers are designed to prevent corrosion between the aluminum body panel and the steel Mounting Brackets.

**Note:** Do not install the Brackets without the Plastic Washers.

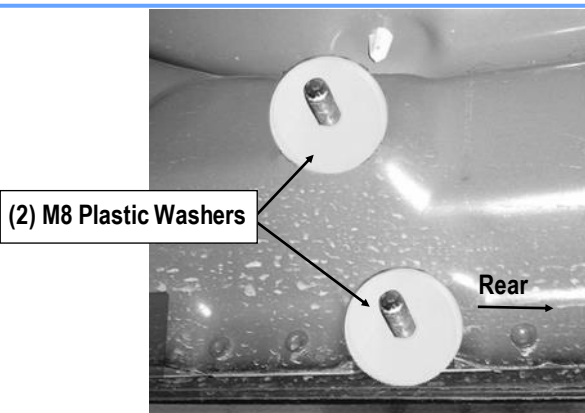

(Fig 2) M8 Plastic Washers Installed

## STEP 3

Select Passenger Front Mounting Bracket (PFM). Attach the Passenger Front Mounting Bracket (PFM) to the (2) factory studs with (2) M8 Flat Washers and (2) M8 Nylon Lock Nuts, (Fig 3). Do not fully tighten hardware at this time.

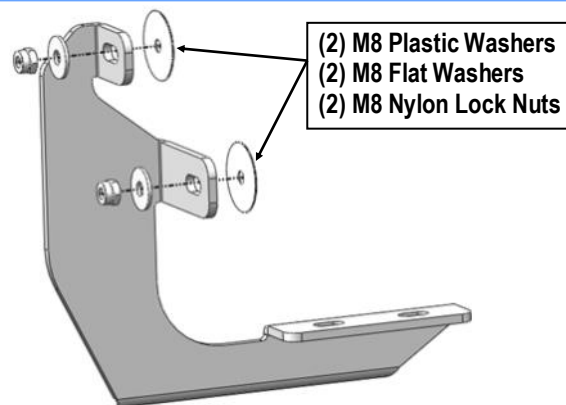

(Fig 3) Passenger Front Mounting Bracket Installation

## STEP 4

Move to the Passenger Side Center & Rear Locations of the vehicle. Select (2) Passenger Center / Rear Mounting Brackets (PCM/PRM). Repeat **Steps 1—3** to install the passenger side Center & Rear Mounting Brackets.

## STEP 5

Once all (3) Passenger side mounting brackets are installed, then proceed to the Step Bar installation. (Figs 4 & 5)

- (1) Select (1) Slider and (2) M8X1.25-35mm Carriage Bolts;
- (2) Install (2) M8X1.25-35mm Carriage Bolts in (1) Slider.
- (3) Slide the Slider (with carriage bolts) to the **Step Bar**.
- (4) Repeat to install the other (2) sliders to the step bar.
- (5) Attach the Step Bar (with the Sliders) onto the installed mounting brackets. Position the Sliders to the installed brackets. Secure the Step Bar to the installed Brackets by using (6)

# iBoard®



Scan for  
Installation Video

M8 Large Flat Washers and (6) M8 Nylon Lock Nuts and (3) Sliders, (Fig 5). Do not fully tighten hardware at this time.

**Note:** The Sliders are packed with the Mounting Brackets.

Level and adjust the Step Bar and fully tighten all hardware.

Repeat **Steps 1-5** for the other side Step Bar installation. **The installation is completed!!!**

## Attention

Do periodic inspections to the installation to make sure that all hardware is secure and tight.

In order to protect your bars/boards, please use mild soap/non-abrasive products for cleaning only.

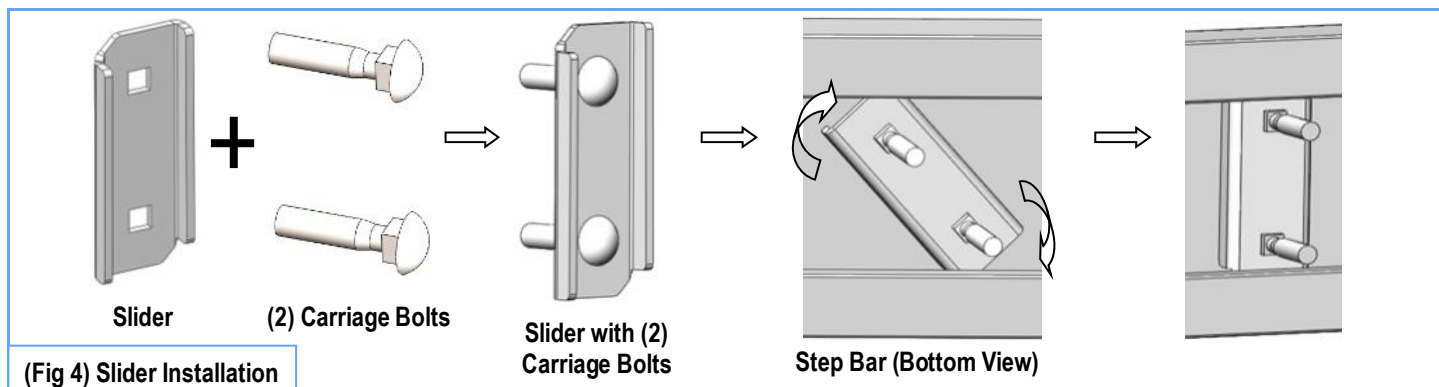

(Fig 4) Slider Installation

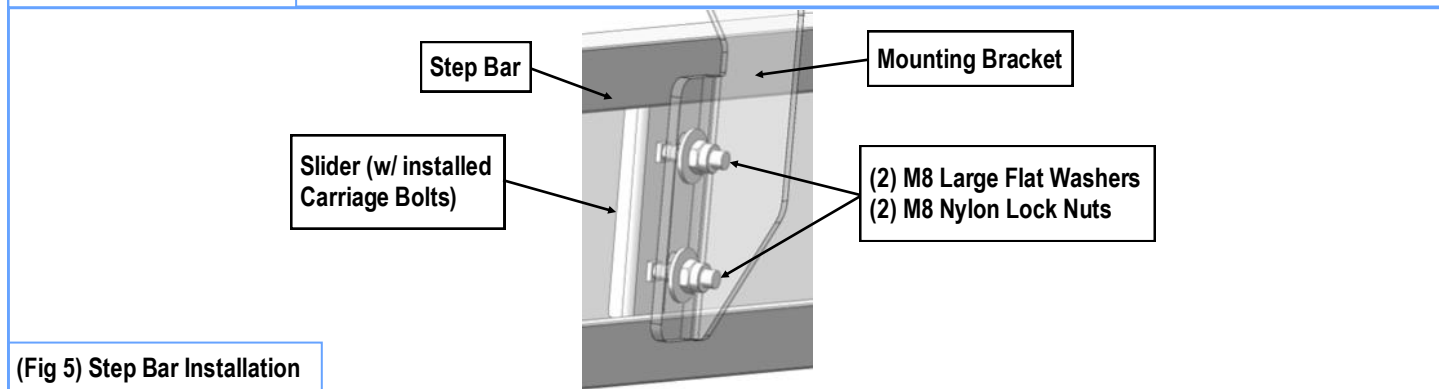

(Fig 5) Step Bar Installation