

iBoard®



Scan for
Installation Video

iBoard® by APS

PART#: IB-008C&H

READ INSTRUCTIONS CAREFULLY BEFORE STARTING INSTALLATION. REMOVE CONTENTS FROM BOX AND VERIFY ALL PARTS ARE PRESENT. ASSISTANCE IS RECOMMENDED.

*ROCKER PANEL MOUNT
*NO DRILLING REQUIRED

Fastener Size	Tightening Torque (ft-lbs)	Required
6mm	6-7	X
8mm	16-18	√
10mm	31-32	√
12mm	56-58	X
14mm	92-94	X

PART LIST

Driver Side Step Bar

Front

Passenger Side Step Bar

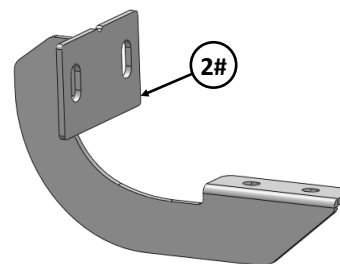
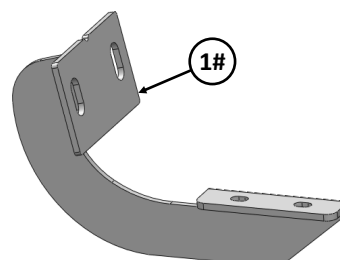
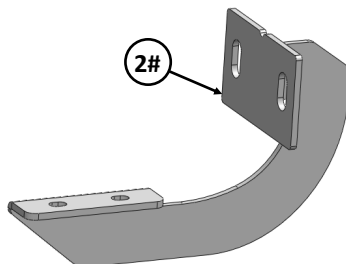
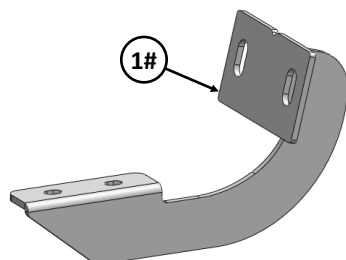



Mounting Bracket List					
Item	QTY	Description	Item	QTY	Description
1#	2	Driver / Passenger Front Mounting Brackets	2#	2	Driver / Passenger Rear Mounting Brackets

Hardware Package A (For Bracket Installation)					
Item	QTY	Description	Item	QTY	Description
1#	4	M10 Large Double Bolt Plates	4#	8	M10 Large Flat Washers
2#	1	M10 Small Double Bolt Plates	5#	8	M10 Lock Washers
3#	2	M10 Plastic Washers	6#	8	M10 Hex Nuts



1 #



2 #



3 #



4 #



5 #



6 #

Hardware Package B (For Stainless Steel Step Bar Installation)					
Item	QTY	Description	Item	QTY	Description
1#	8	M8X1.25-35mm Carriage Bolts	3#	8	M8 Nylon Lock Nuts
2#	8	M8 Large Flat Washers	4#	4	Sliders (Packed with Step Bars)

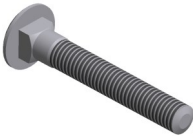

1 #



2 #



3 #



4 #



STEP 1

Starting on the driver side front mounting location of the vehicle. Remove the large oval rubber cover located on the inner side of the body panel, (Fig 1). Insert (1) M10 Large Double Bolt Plate into the oval hole, (Fig 2) and pull it back into position against the inner body panel, (Fig 3).

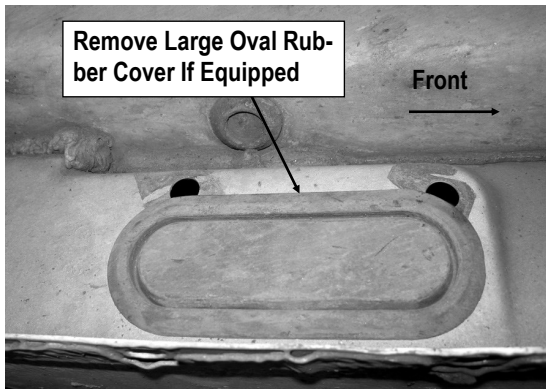

(Fig 1) Driver Side Front Mounting Location

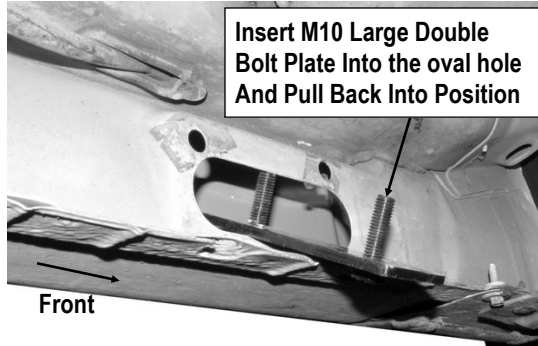

(Fig 2) Insert Large Double Bolt Plate

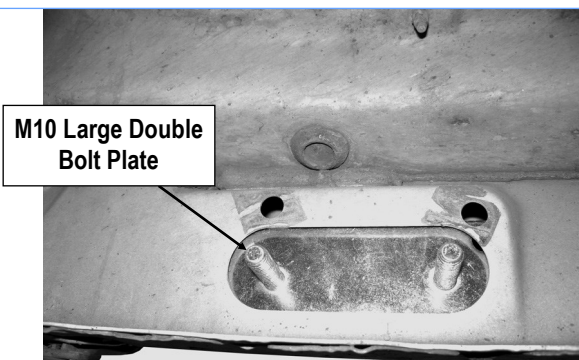

(Fig 3) Large Double Bolt Plate Installed

STEP 2

Select (1) Driver Front Mounting Bracket. Secure the Driver Front Mounting Bracket to the M10 Large Double Bolt Plate with the included (2) M10 Lock Washers, (2) M10 Large Flat Washers and (2) M10 Hex Nuts, (Fig 4). Do not fully tighten hardware at this time.

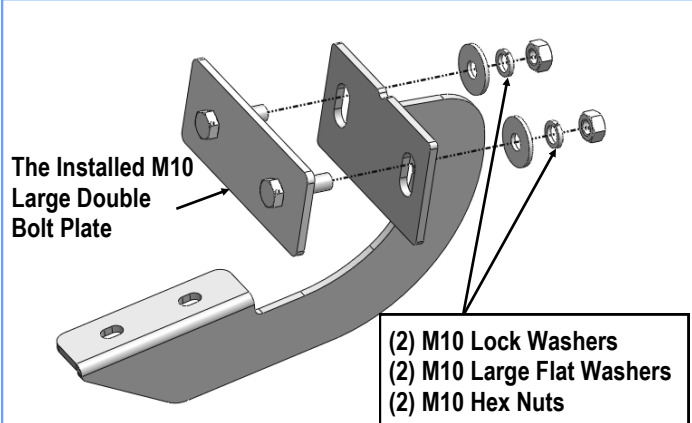

(Fig 4) Driver Front Mounting Bracket Installation

STEP 3

Move to Driver Side Rear Mounting Location. Repeat **Steps 1-2** for Driver Rear Mounting Bracket installation. Do not fully tighten hardware at this time.

NOTE: On 3-door models, insert the M10 Small Double Bolt Plate into the large, round hole and line up with the smaller round hole, (Fig 5). Then use the included Plastic Washers to hold the Bolt Plate in position and secure the Bracket as previously described in **Step 1-2**.

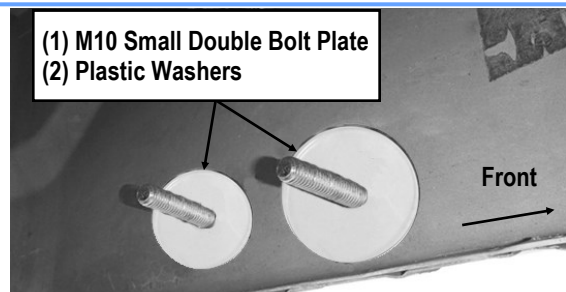

(Fig 5) Use For Driver Side Rear 3-Door Models



STEP 4

Once all (2) Driver side mounting brackets are installed, then proceed to the Step Bar installation. (Figs 6 & 7)

- (1) Select (1) Slider and (2) M8X1.25-35mm Carriage Bolts;
- (2) Install (2) M8X1.25-35mm Carriage Bolts in (1) Slider.
- (3) Slide the Slider (with carriage bolts) to the **Step Bar**.
- (4) Repeat to install the other (1) slider to the step bar.
- (5) Attach the Step Bar (with the Sliders) onto the installed mounting brackets. Position the Sliders to the installed brackets. Secure the Step Bar to the installed Brackets by using (4) M8 Large Flat Washers and (4) M8 Nylon Lock Nuts and (2) Sliders, (Fig 6). Do not fully tighten hardware at this time.

Note: The Sliders are packed with the Step Bars.

Level and adjust the Step Bar and fully tighten all hardware.

Repeat **Steps 1-4** for the other side Step Bar installation. **The installation is completed!!!**

Attention

Do periodic inspections to the installation to make sure that all hardware is secure and tight.

In order to protect your bars/boards, please use mild soap/non-abrasive products for cleaning only.

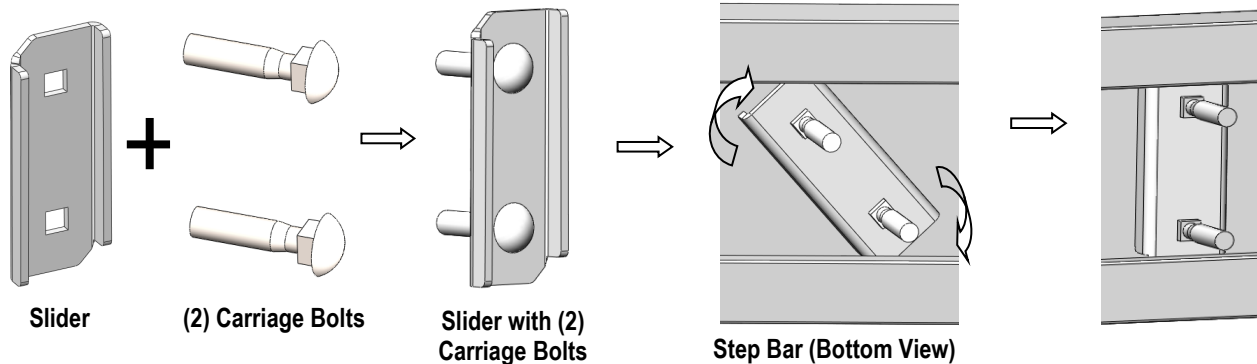

(Fig 6) Slider Installation

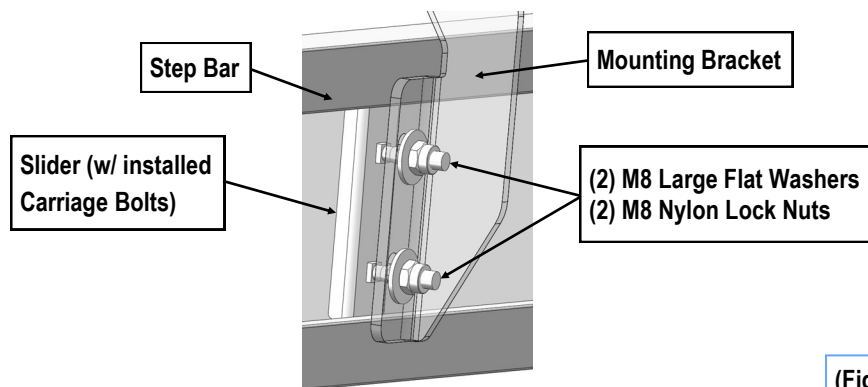

(Fig 7) Step Bar Installation