



iBoard® by APS

PART#: IB-312C&H

READ INSTRUCTIONS CAREFULLY BEFORE STARTING INSTALLATION. REMOVE CONTENTS FROM BOX AND VERIFY ALL PARTS ARE PRESENT. ASSISTANCE IS RECOMMENDED.

*ROCKER PANEL MOUNT
*NO DRILLING REQUIRED

Fastener Size	Tightening Torque (ft-lbs)	Required
6mm	6-7	X
8mm	16-18	√
10mm	31-32	√
12mm	56-58	X
14mm	92-94	X

PART LIST

Driver Side Step Bar

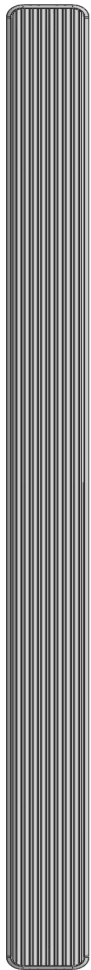

Front
↑

Passenger Side Step Bar

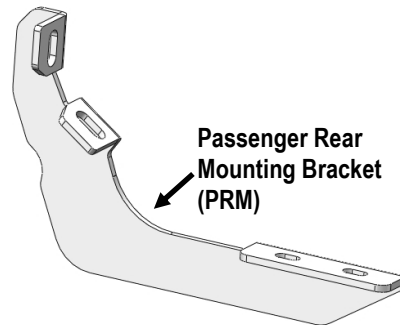
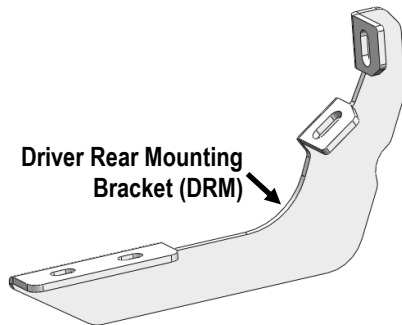
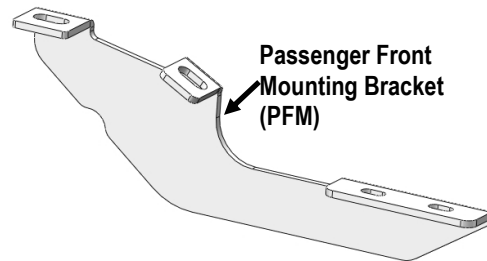
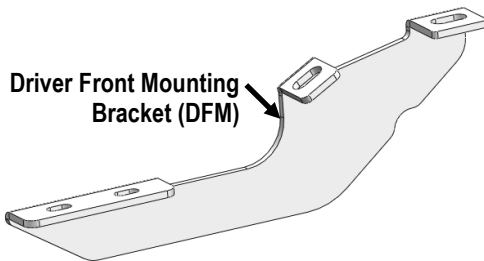
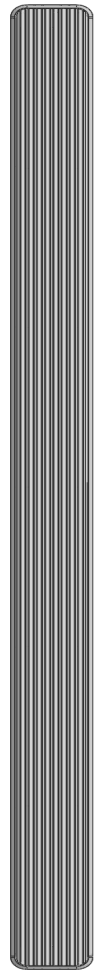



Hardware Package A (For Bracket Installation)

Item	QTY	Description	Item	QTY	Description
1#	8	M10X1.5-30mm Hex Bolts	3#	8	M10 Lock Washers
2#	8	M10 Flat Washers			

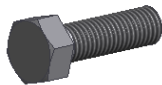

1#



2#



3#

Hardware Package B (For Stainless Steel Step Bar Installation)

Item	QTY	Description	Item	QTY	Description
1#	8	M8X1.25-35mm Carriage Bolts	3#	8	M8 Nylon Lock Nuts
2#	8	M8 Large Flat Washers	4#	4	Sliders (Packed with Step Bars)

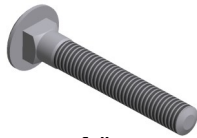

1 #



2 #



3 #

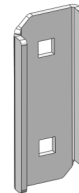

4 #



STEP 1

Start installation from the Passenger side front of the vehicle, locate the threaded holes in the body panel, **(Fig 1)**. Remove the plastic plugs covering the holes.

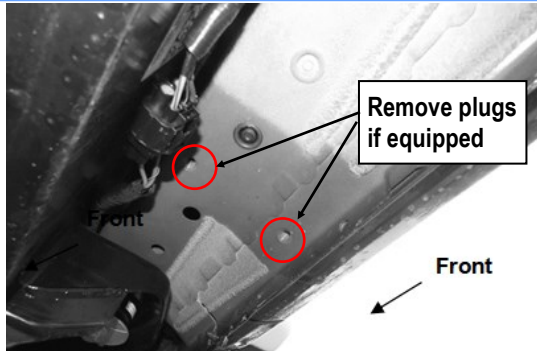

(Fig 1) Passenger Side Front Mounting Location

STEP 2

Select Passenger Front Mounting Bracket (PFM) and attach it to the front mounting location with (2) M10 Hex Bolts, (2) M10 Flat Washers, (2) M10 Lock Washers, **(Fig 2)**. Do not fully tighten hardware at this time.

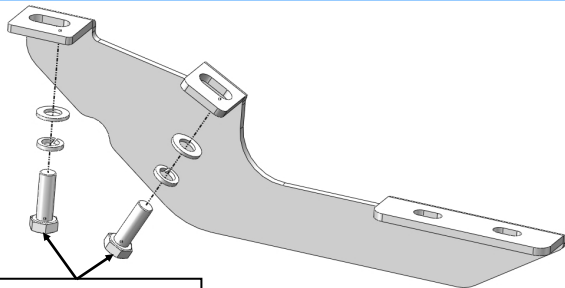

(2) M10 Flat Washers
(2) M10 Lock Washers
(2) M10 Hex Bolts

(Fig 2) Passenger Front Mounting Bracket Installation

STEP 3

Move to Passenger Side Rear mounting location, **(Fig 3)**. Repeat **Steps 1 & 2** to attach Passenger Rear Mounting Bracket (PRM) to the rear mounting location, **(Fig 4)**. Do not fully tighten hardware at this time.

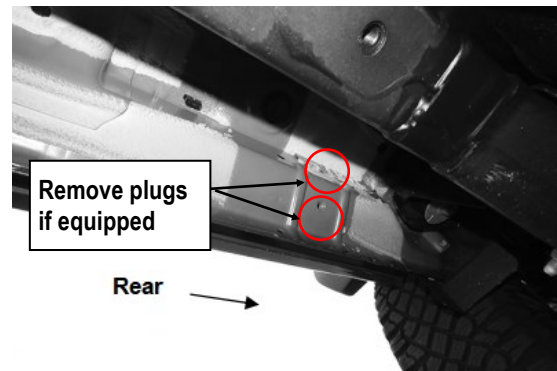

(Fig 3) Passenger Side Rear Mounting Location

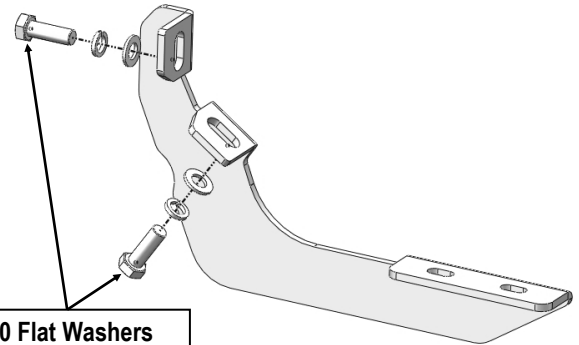

(2) M10 Flat Washers
(2) M10 Lock Washers
(2) M10 Hex Bolts

(Fig 4) Passenger Side Rear Mounting Brackets Installation

STEP 4

Once all (2) Passenger side mounting brackets are installed, then proceed to the Step Bar installation. **(Figs 5 & 6)**

- (1) Select (1) Slider and (2) M8X1.25-35mm Carriage Bolts;
- (2) Install (2) M8X1.25-35mm Carriage Bolts in (1) Slider.
- (3) Slide the Slider (with carriage bolts) to the **Step Bar**.
- (4) Repeat to install the other (1) slider to the step bar.
- (5) Attach the Step Bar (with the Sliders) onto the installed mounting brackets. Position the Sliders to the installed brackets. Secure the Step Bar to the installed Brackets by using (4) M8 Large Flat Washers and (4) M8 Nylon Lock Nuts and (2) Sliders, **(Fig 6)**. Do not fully tighten hardware at this time.

Note: The Sliders are packed with the Step Bars.



Level and adjust the Step Bar and fully tighten all hardware.
Repeat **Steps 1-4** for the other side Step Bar installation. **The installation is completed!!!**

Attention

Do periodic inspections to the installation to make sure that all hardware is secure and tight.

In order to protect your bars/boards, please use mild soap/non-abrasive products for cleaning only.

