

# iBoard®



Scan for  
Installation Video

## iBoard® by APS

PART#: IB-P030Y&H

READ INSTRUCTIONS CAREFULLY BEFORE STARTING INSTALLATION. REMOVE CONTENTS FROM BOX AND VERIFY ALL PARTS ARE PRESENT. ASSISTANCE IS RECOMMENDED.

\*ROCKER PANEL MOUNT  
\*NO DRILLING REQUIRED

Fastener Size	Tightening Torque (ft-lbs)	Required
6mm	6-7	X
8mm	16-18	√
10mm	31-32	√
12mm	56-58	X
14mm	92-94	X

### PART LIST

#### Driver Side Step Bar



Front



#### Passenger Side Step Bar

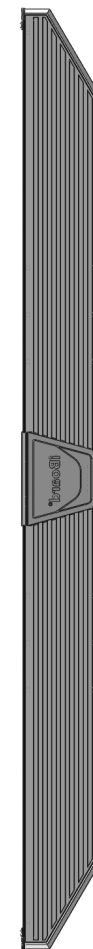

Driver Front  
Mounting Bracket  
(DFM)

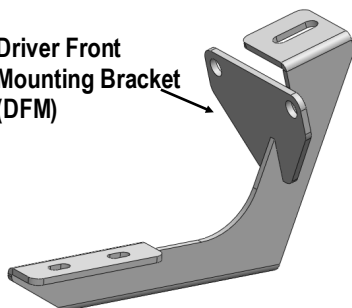

Passenger Front  
Mounting Bracket  
(PFM)

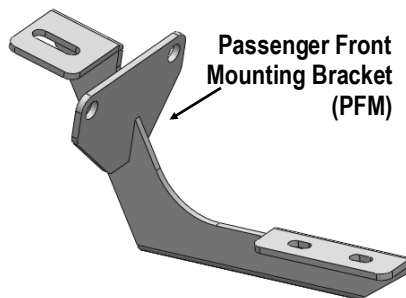

Driver Rear  
Mounting Bracket  
(DRM)

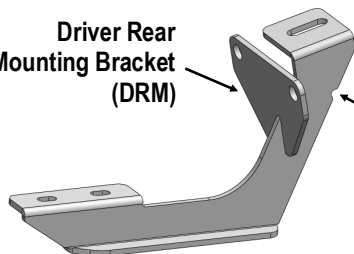

Passenger Rear  
Mounting Bracket  
(PRM)

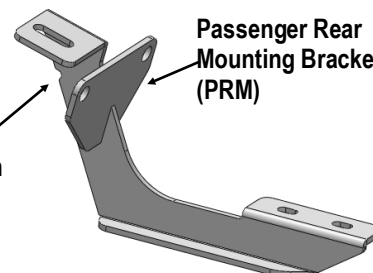

Rear Mounting  
Brackets W/ Notch









Scan for  
Installation Video

## Hardware Package A (For Bracket Installation)

Item	QTY	Description	Item	QTY	Description
1#	4	M10X1.5-25 Bolt Plates	5#	8	M8X1.25-25 Hex Bolts
2#	4	M10 Plastic Washers	6#	16	M8 Large Flat Washers
3#	4	M10 Flat Washers	7#	8	M8X1.25 Nylon Lock Nuts
4#	4	M10X1.5 Nylon Lock Nuts			





  

						
1 #	2 #	3 #	4 #	5 #	6 #	7 #

## Hardware Package B (For Step Bar Installation)

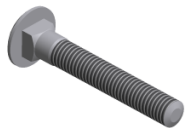
Item	QTY	Description	Item	QTY	Description
1#	8	M8X1.25-35mm Carriage Bolts	3#	8	M8 Nylon Lock Nuts
2#	8	M8 Large Flat Washers	4#	4	Sliders (Packed with Mounting Brackets)

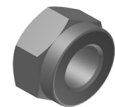

			
1 #	2 #	3 #	4 #



## STEP 1

Start installation from the driver side front of the vehicle. Insert (1) M10 Bolt Plate into the rectangular hole located in the side panel, and M10 welded Bolt drops through the round hole (**Fig 1**).

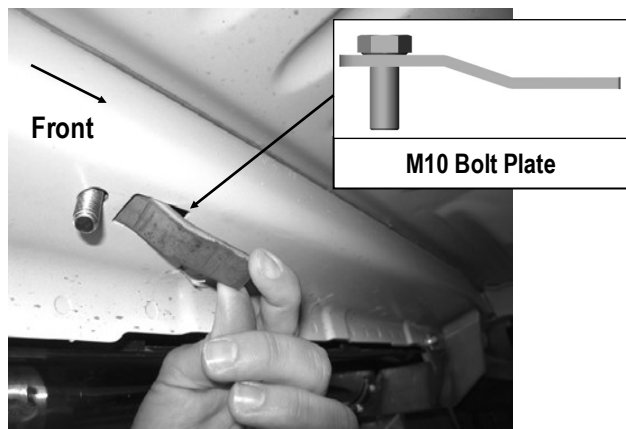

(Fig 1) Driver Side Front Mounting Location

## STEP 2

Select the Driver Front Mounting Bracket (**DFM**). Attach the Driver Front Mounting Bracket to the inserted M10 Bolt Plate with (1) M10 Plastic Washer, (1) M10X1.5 Nylon Lock Nut and (1) M10 Flat Washer, (**Figs 2 & 3**). Do not fully tighten hardware at this time.

## STEP 3

Attach the Driver Front Mounting Bracket to pinch weld using: (2) M8X1.25-25mm Hex Bolts, (2) M8X1.25 Nylon Lock Nuts, and (4) M8 Large Flat Washers, (**Figs 2 & 3**). Do not fully tighten hardware at this time.

**Note:** Make sure that the vertical mounting plate on Bracket is on the outer side of the pinch weld.

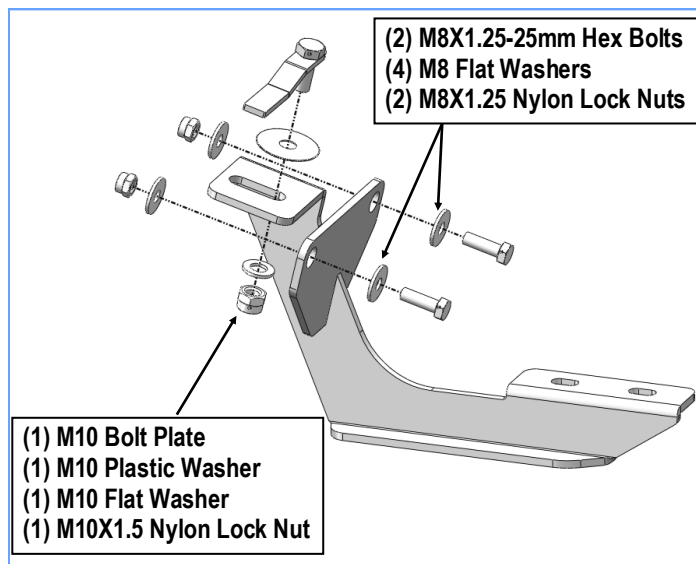

(Fig 2) Driver Front Mounting Bracket Installation

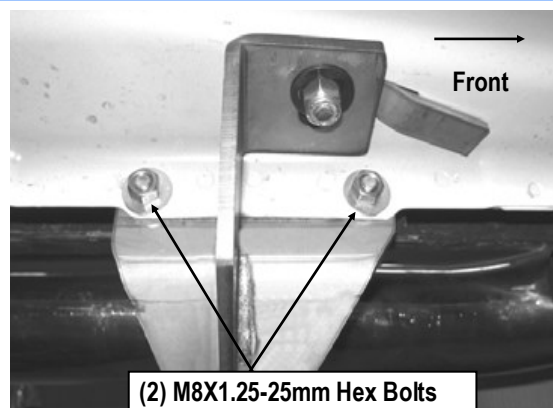

(Fig 3) Driver Front Mounting Bracket Installed

## STEP 4

Move to the driver side rear of the vehicle. Repeat **Steps 1-3** to install the Driver Rear Mounting Bracket (**DRM**). Don't fully tighten hardware at this time.



## STEP 5

Once all (2) Driver side mounting brackets are installed, then proceed to the Step Bar installation. (Figs 4 & 5)

- (1) Select (1) Slider and (2) M8X1.25-35mm Carriage Bolts;
- (2) Install (2) M8X1.25-35mm Carriage Bolts in (1) Slider.
- (3) Slide the Slider (with carriage bolts) to the **Step Bar**.
- (4) Repeat to install the other (1) slider to the step bar.
- (5) Attach the Step Bar (with the Sliders) onto the installed mounting brackets. Position the Sliders to the installed brackets. Secure the Step Bar to the installed Brackets by using (4) M8 Large Flat Washers and (4) M8 Nylon Lock Nuts and (2) Sliders, (Fig 5). Do not fully tighten hardware at this time.

**Note:** The Sliders are packed with the Mounting Brackets.

Level and adjust the Step Bar and fully tighten all hardware.

Repeat **Steps 1-5** for the other side Step Bar installation. **The installation is completed!!!**

### Attention

Do periodic inspections to the installation to make sure that all hardware is secure and tight.

In order to protect your bars/boards, please use mild soap/non-abrasive products for cleaning only.

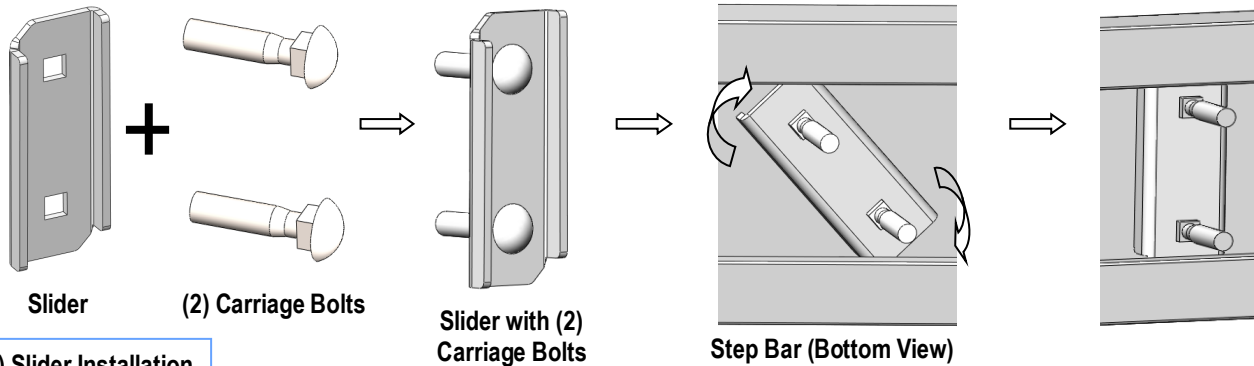

(Fig 4) Slider Installation

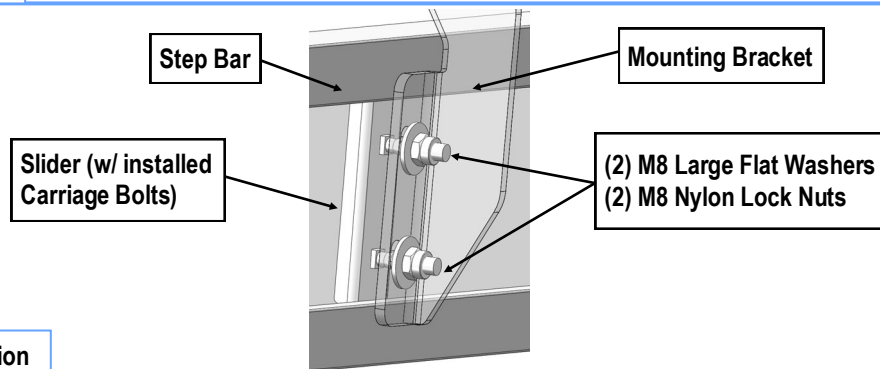

(Fig 5) Step Bar Installation