

iBoard®



Scan for
Installation Video

iBoard® by APS

PART#: IB-P208/P209Y&H

READ INSTRUCTIONS CAREFULLY BEFORE STARTING INSTALLATION. REMOVE CONTENTS FROM BOX AND VERIFY ALL PARTS ARE PRESENT. ASSISTANCE IS RECOMMENDED.

*ROCKER PANEL MOUNT
*DRILLING MAY BE REQUIRED

Fastener Size	Tightening Torque (ft-lbs)	Required
6mm	6-7	√
8mm	16-18	√
10mm	31-32	X
12mm	56-58	X
14mm	92-94	X

PART LIST

Driver Side Step Bar

Front
↑



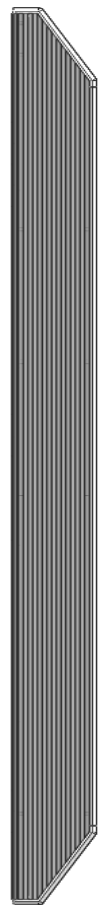
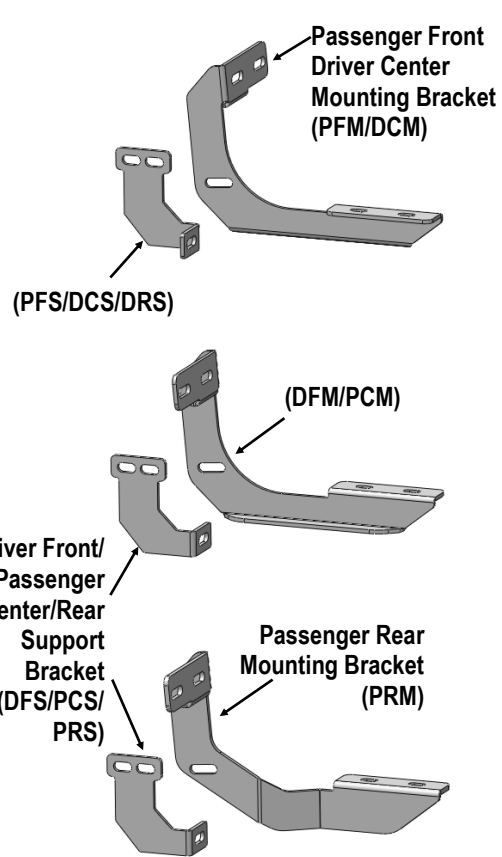
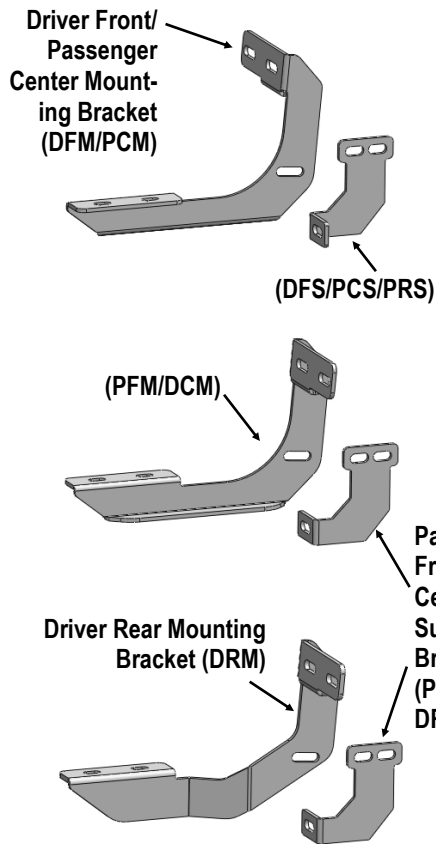
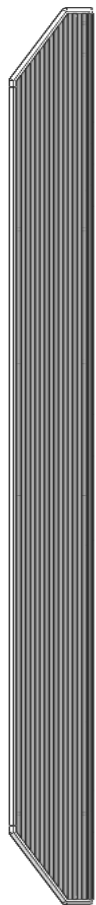





Passenger Side Step Bar

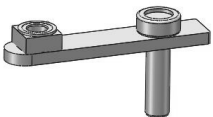

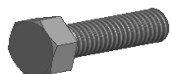

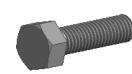

Customer Support: info@iboardauto.com

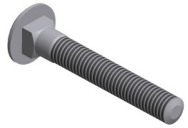

Hardware Package A (For Bracket Installation)					
Item	QTY	Description	Item	QTY	Description
1#	6	M8 Bolt/Nut Plates	6#	6	M8 Nylon Lock Nut
2#	6	M8 Plastic Washers	7#	6	M8 Hex Nuts
3#	18	M8X1.25-30mm Hex Bolts	8#	12	M6X1-25mm Hex Bolts
4#	24	M8 Large Flat Washers	9#	24	M6 Large Flat Washers
5#	12	M8 Lock Washers	10#	12	M6 Nylon Lock Nuts

									
1 #	2 #	3 #	4 #	5 #	6 #	7 #	8 #	9 #	10 #

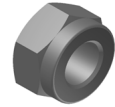
Hardware Package B (For Step Bar Installation)					
Item	QTY	Description	Item	QTY	Description
1#	12	M8X1.25-35mm Carriage Bolts	3#	12	M8 Nylon Lock Nuts
2#	12	M8 Large Flat Washers	4#	6	Sliders (Packed with Mounting Brackets)

			
1 #	2 #	3 #	4 #



STEP 1

Start installation on the driver side of the vehicle. If equipped, remove the sealing tapes covering the factory oval holes on the inner side of the body panel, **(Fig 1)**.

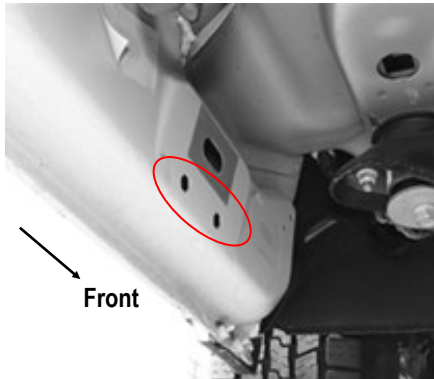

(Fig 1) Driver Side Front Mounting Location

STEP 2

Determine the correct procedure to attach one driver side Bracket for your model/year:

Models without factory threaded inserts in body panel:

- Partially thread an M8x1.25-30mm Hex Bolt onto the threaded end of a M8 Nut/Bolt Plate, **(Fig 2)**. Thread the Hex Bolt in until it is flush with the welded nut, **(Fig 3)**. Use the Hex Bolt as a handle and insert the Nut/Bolt Plate into the oval hole, **(Fig 4)**. Feed the threaded bolt on the Bolt Plate through one of the hex shaped factory holes. Thread (1) M8 Plastic Washer onto the threaded end and down tight against the body panel, **(Fig 5)**. **NOTE:** The Plastic Washer is designed to keep the Nut/Bolt Plate from falling into the body panel and to aid in Bracket installation.
- Select a driver side Mounting Bracket, attach the Bracket to the threaded end of the Bolt Plate with (1) M8 Large Flat Washer, (1) M8 Lock Washer and (1) M8 Hex Nut, **(Fig 6a)**. Do not tighten at this time.
- Remove the M8X1.25-30mm Hex Bolts from the nut on the Bolt Plate from **Step 2a**. Rotate the Bolt on the Bolt Plate until the threaded nut lines up with the remaining

hole in the Mounting Bracket and body panel, **(Fig 6b)**. Attach the Bracket to the threaded Nut Plate with (1) M8X1.25-30mm Hex Bolts, (1) M8 Lock Washer and (1) M8 Large Flat Washer, **(Fig 6b)**. Do not fully tighten hardware at this time.

Models with factory threaded inserts:

Attach the Driver Front Mounting Bracket to the threaded inserts with (2) M8X1.25-30mm Hex Bolts, (2) M8 Lock Washers and (2) M8 Large Flat Washer, **(Figs 7 & 8)**. Leave hardware loose.

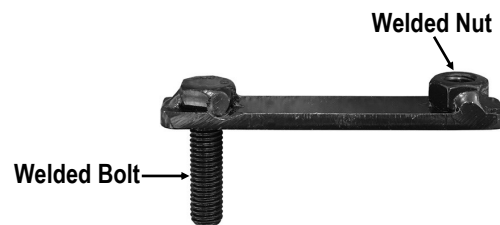

(Fig 2) M8 Nut/Bolt Plate, **NOTE:** M8 Nut/Bolt Plate Is Not Required On Models With Threaded Inserts

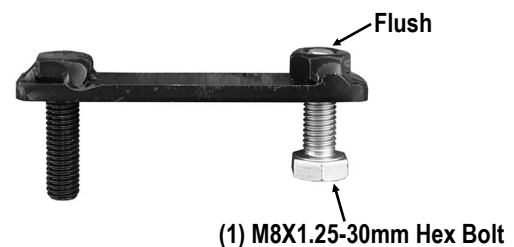

(Fig 3) Thread (1) M8 Hex Bolt Into The Nut On The Plate. Stop When Bolt Reaches End Of Nut As Pictured

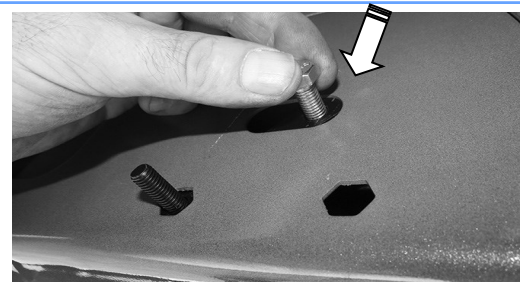

(Fig 4) Use The Loose Hex Bolt As A Handle. Insert The M8 Nut/Bolt Plate Into The Oval Hole And Feed The Threaded End Out Either Factory Hex Shaped Hole.

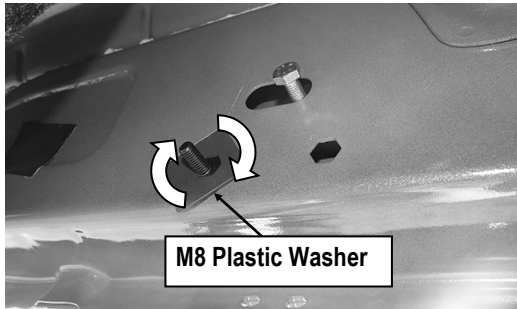

M8 Plastic Washer

(Fig 5) Thread Plastic Washer Onto M8 Nut/Bolt Plate To Hold Nut/Bolt Plate In Position.

IMPORTANT: Do Not Let Go Of The M8 Hex Bolt Until After Plastic Washer Has Been Threaded Onto Bolt

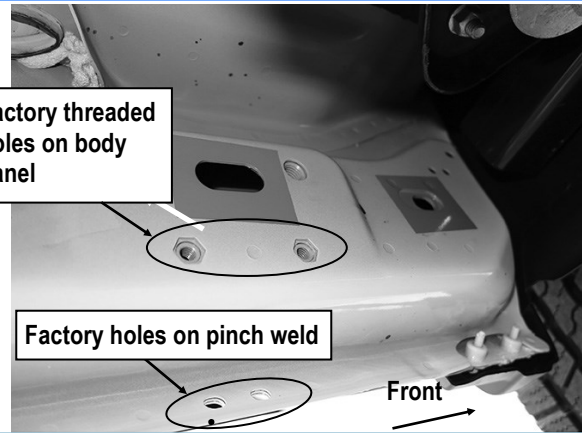

Factory threaded holes on body panel

Factory holes on pinch weld

Front

(Fig 7) Driver Side Front Mounting Location (Mid 2015-On, An Example Of Models With Factory Installed Threaded Inserts)

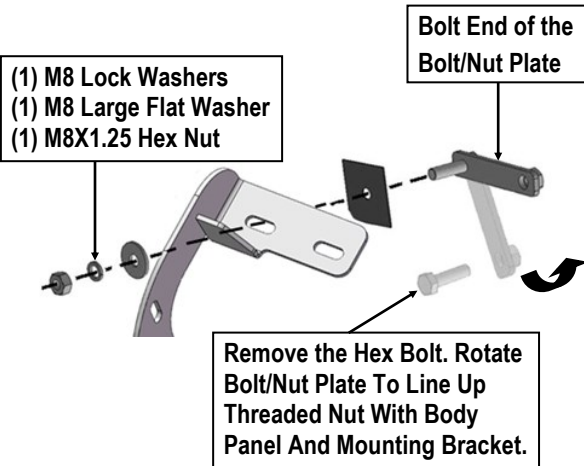

- (1) M8 Lock Washers
- (1) M8 Large Flat Washer
- (1) M8X1.25 Hex Nut

Bolt End of the Bolt/Nut Plate

Remove the Hex Bolt. Rotate Bolt/Nut Plate To Line Up Threaded Nut With Body Panel And Mounting Bracket.

(Fig 6a) Attach Bracket to Bolt end of the Bolt/Nut Plate

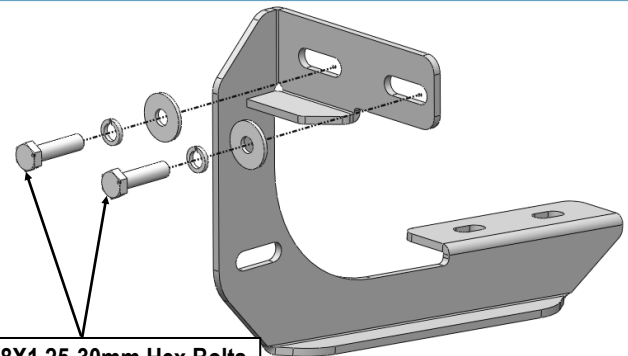

- (2) M8X1.25-30mm Hex Bolts
- (2) M8 Lock Washers
- (2) M8 Large Flat Washers

(Fig 8) Driver Front Mounting Bracket Installation (For Models With Factory Installed Threaded Inserts. Bolt Plate Not Required)

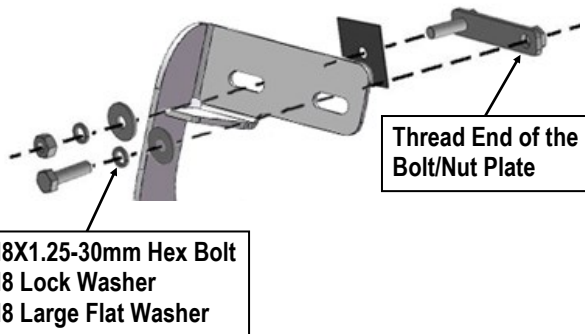

- (1) M8X1.25-30mm Hex Bolt
- (1) M8 Lock Washer
- (1) M8 Large Flat Washer

Thread End of the Bolt/Nut Plate

(Fig 6b) Attach the Bracket to Threaded End of the Bolt/Nut Plate

STEP 3

Next, select (1) Driver Front Support Bracket (DFS/PCS/PRS). Attach the Bracket to the front facing side of the front Bracket with (1) M8X1.25-30mm Hex Bolt, (2) M8 Large Flat Washers and (1) M8X1.25 Nylon Lock Nut, (Fig 9). Rotate the Support Bracket to the back of the pinch weld. Line up the slots in the top of the Support Bracket with the (2) factory holes in the pinch weld. Attach the Bracket to the back of the pinch weld with (2) M6X1-25mm Hex Bolts, (4) M6 Large Flat Washers and (2) M6X1 Nylon Lock Nuts, (Fig 10). Do not fully tighten hardware at this time.



IMPORTANT: Some models are not equipped with factory holes and will require drilling through the pinch weld to attach the Support Bracket. Do not drill through pinch weld at this time.

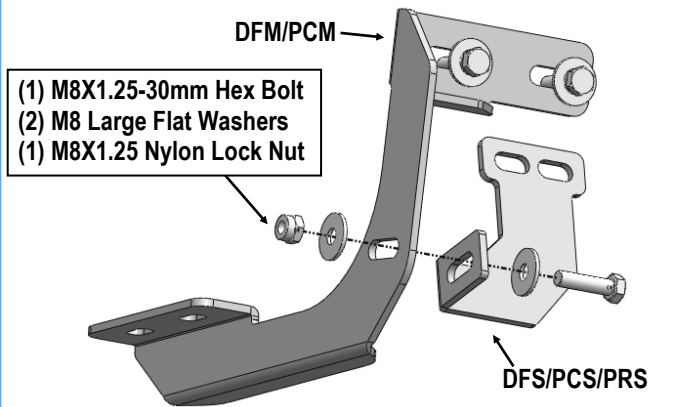

(Fig 9) Attach Driver Front Support Bracket to the Driver Front Mounting Bracket

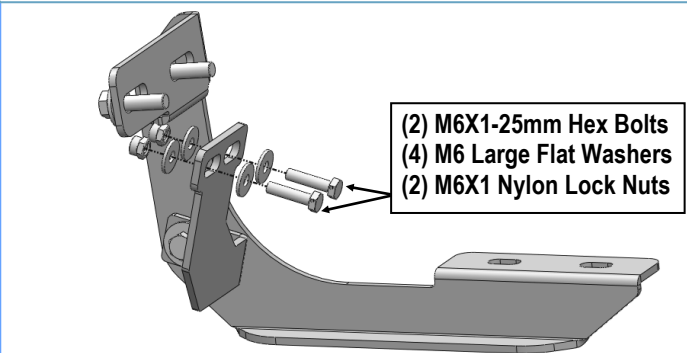

(Fig 10) Attach Support Bracket to the Back of Pinch Weld (Some Models May Require to Drill Holes on Pinch Weld)

STEP 4

Move along the side of the body panel to the center and rear mounting location, (Figs 11 & 12). Repeat **Steps 2-3** to install the driver side center & rear Brackets, (Fig 13).

IMPORTANT: The front and center driver side Brackets are universal.

IMPORTANT: Some models without holes in pinch weld will require drilling 1/4" holes through pinch weld to attach driver side front support bracket. Do complete installation of the Driver Side Bar first, level board before drilling holes for support bracket.

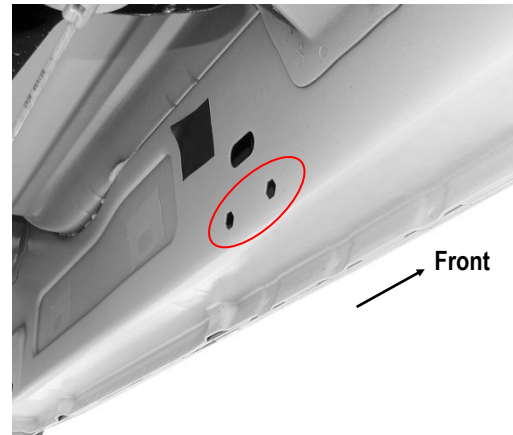

(Fig 11) Driver Side Center Mounting Location

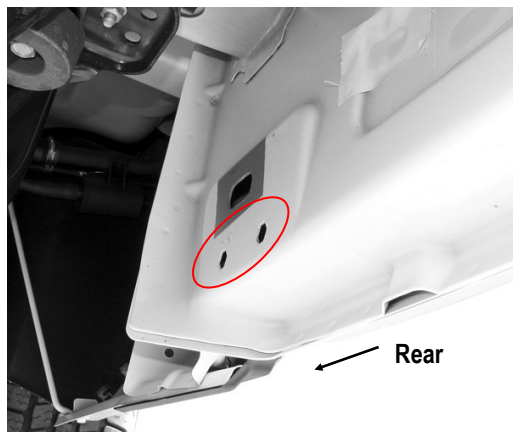

(Fig 12) Driver Side Rear Mounting Location

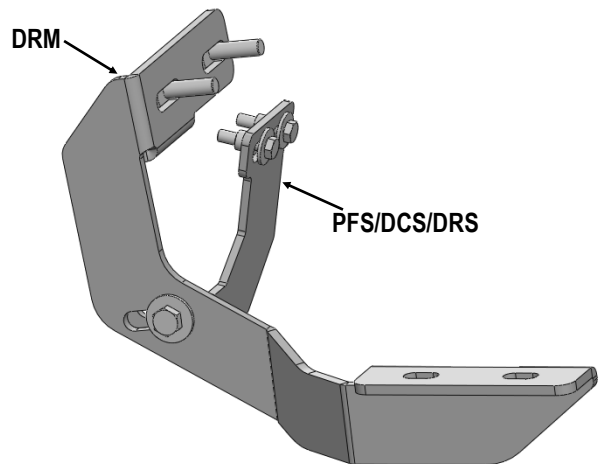

(Fig 13) Driver Side Rear Brackets Installation



STEP 5

Once all (3) Driver side mounting brackets are assembled, then proceed to the Step Bar installation. (**Figs 14 & 15**)

- (1) Select (1) Slider and (2) M8X1.25-35mm Carriage Bolts;
- (2) Install (2) M8X1.25-35mm Carriage Bolts in (1) Slider.
- (3) Slide the Slider (with carriage bolts) to the **Step Bar**.
- (4) Repeat to install the other (2) sliders to the step bar.
- (5) Attach the Step Bar (with the Sliders) onto the installed mounting brackets. Position the Sliders to the installed brackets. Secure the Step Bar to the installed Brackets by using (6) M8 Large Flat Washers and (6) M8 Nylon Lock Nuts and (3) Sliders, (**Fig 15**). Do not fully tighten hardware at this time.

Note: The Sliders are packed with the Mounting Brackets.

Level and adjust the Step Bar and fully tighten all hardware.

Repeat **Steps 1-5** for the other side Step Bar installation. **The installation is completed!!!**

Attention

Do periodic inspections to the installation to make sure that all hardware is secure and tight.

In order to protect your bars/boards, please use mild soap/non-abrasive products for cleaning only.

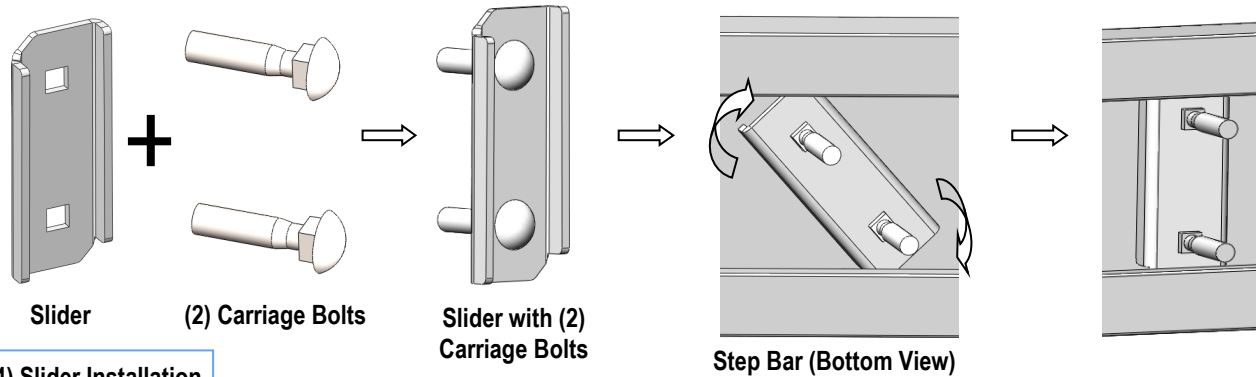

(Fig 14) Slider Installation

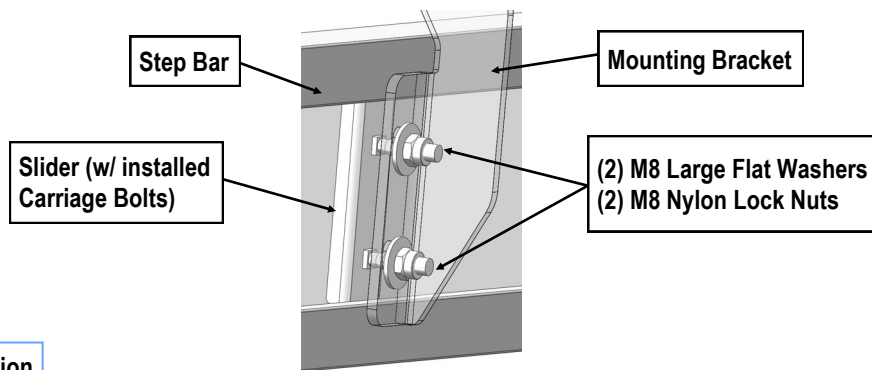

(Fig 15) Step Bar Installation