



iBoard® Series

INSTALLATION INSTRUCTIONS

PART#: IB-P001 [L,S] Y&H

BEFORE INSTALLATION

REMOVE ALL CONTENTS FROM BOX. VERIFY ALL PARTS ARE PRESENT. READ INSTRUCTIONS CAREFULLY BEFORE STARTING INSTALLATION. ASSISTANCE IS RECOMMENDED. THANK YOU FOR CHOOSING OUR PRODUCT!

***BODY FRAME MOUNT**

***NO DRILLING REQUIRED**

Torque Value

Fastener Size	Tightening Torque (ft-lbs)	Required
6mm	6-7	No
8mm	16-18	Yes
10mm	31-32	Yes
12mm	56-58	No
14mm	92-94	No



Scan for
Installation Video

Mounting Bracket List							
Item	QTY	Bracket Label	Description	Item	QTY	Bracket Label	Description
1#	1	DFM	Mounting Bracket for Driver Front	5#	1	PFM	Mounting Bracket for Passenger Front
2#	1	DCM	Mounting Bracket for Driver Center	6#	1	PCM	Mounting Bracket for Passenger Center
3#	1	DRM	Mounting Bracket for Driver Rear	7#	1	PRM	Mounting Bracket for Passenger Rear
4#	1	DRB	Bar Bracket for Driver Rear	8#	1	PRB	Bar Bracket for Passenger Rear

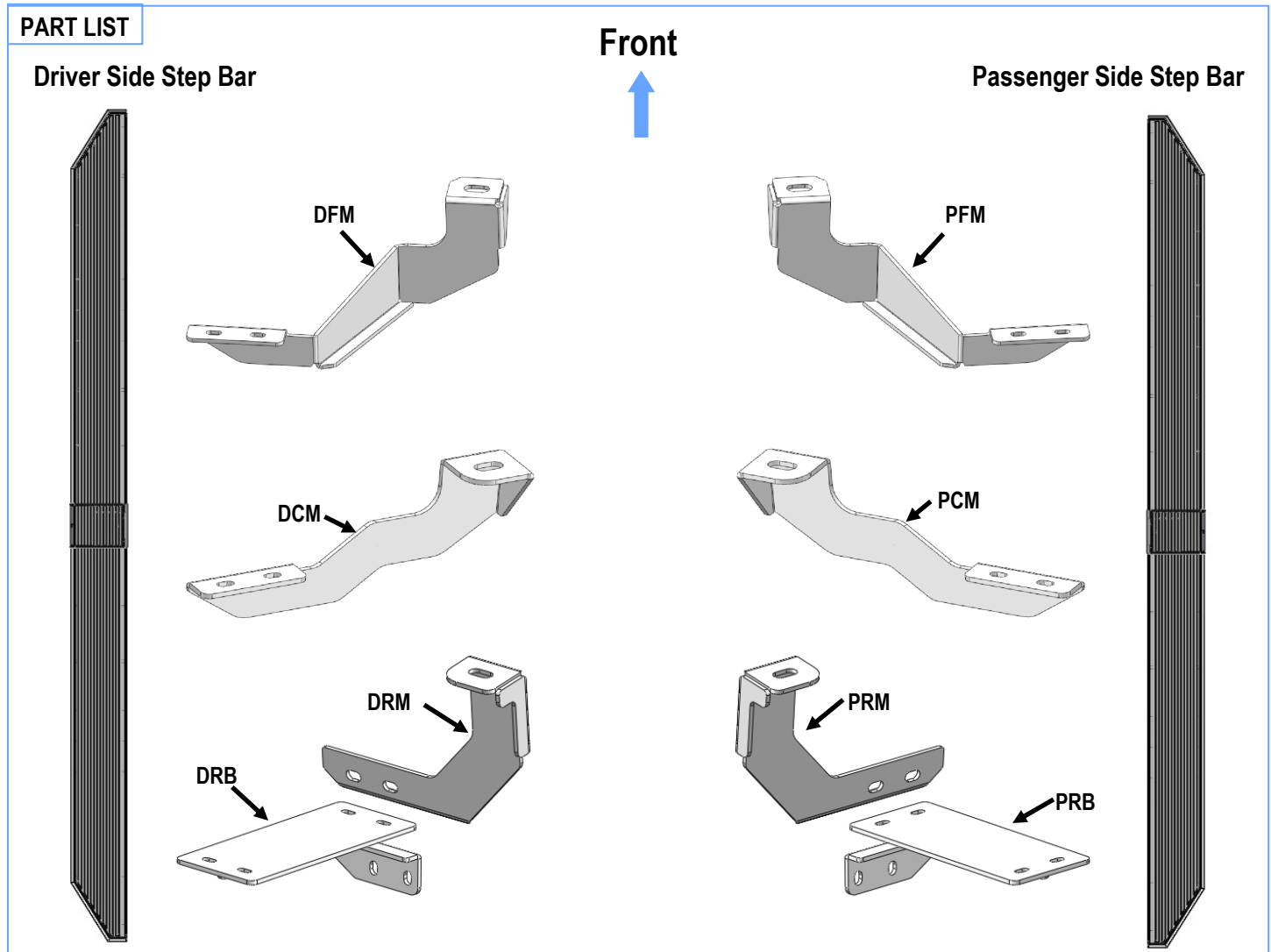



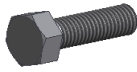

Hardware Package A (For Bracket Installation)					
Item	QTY	Description	Item	QTY	Description
A1	4	M10X1.5-30mm Hex Bolts	A3	4	M10 Lock Washers
A2	8	M10 Large Flat Washers	A4	4	M10X1.5 Hex Nut



A1



A2



A3



A4

Hardware Package B (For Stainless Steel Step Bar Installation)					
Item	QTY	Description	Item	QTY	Description
B1	16	M8X1.25-35mm Carriage Bolts	B3	16	M8 Nylon Lock Nuts
B2	16	M8 Large Flat Washers	B4	8	Sliders (Packed with Mounting Brackets)

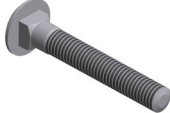

B1



B2



B3



B4

Hardware Package C (For Stainless Steel Step Bar Assembly)					
Item	QTY	Description	Item	QTY	Description
C1	8	Plastic Rivets	C5	4	M8 Hex Nuts
C2	12	M8X1.25-25mm Inner Hex Bolts	C6	2	Plastic Covers (Packed with Step Bars)
C3	16	M8 Flat Washers	C7	2	Back Plates (Packed with Step Bars)
C4	12	M8 Lock Washers			



C1

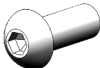

C2



C3



C4



C5

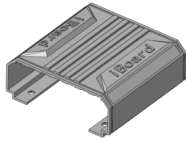

C6



C7



STEP 1: Step Bar Assembly

Step Bar Assembly:

1. Select and assemble (2) Step Bars (**Fig. 1**) with :

- (2) C2 (M8X1.25-25mm Inner Hex Bolts)
- (4) C3 (M8 Flat Washers)
- (2) C4 (M8 Lock Washers)
- (2) C5 (M8 Hex Nuts)

NOTE: This kit includes 4 step bar sections. Select 2 matching sections (from different pairs) to assemble one complete step bar.

2. Attach (1) C7 (Back Plate) to the bottom of the installed (2) Step Bars (**Fig. 2**) with:

- (4) C2 (M8X1.25-25mm Inner Hex Bolts)
- (4) C3 (M8 Flat Washers)
- (4) C4 (M8 Lock Washers)

3. Install (1) Plastic Cover to cover the joint of (2) Step bars with (4) Plastic Rivets (**Fig. 3**).

4. Repeat to assemble the other (2) Step Bars.

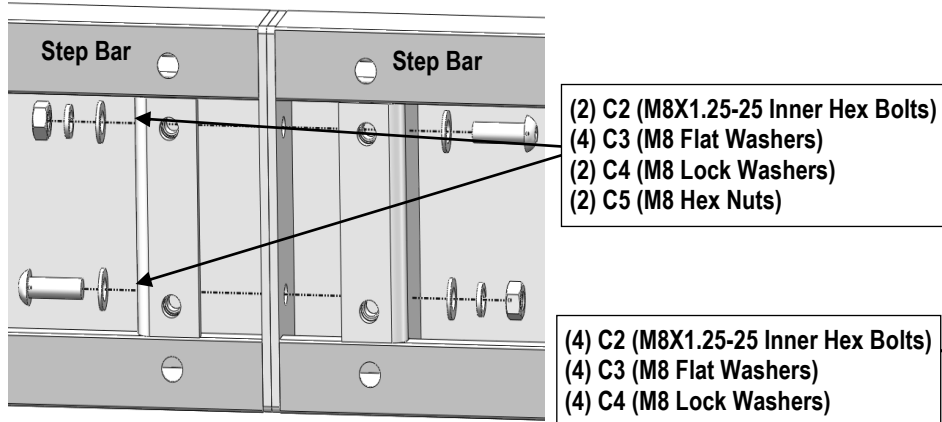

(Fig. 1) Step Bars Assembly

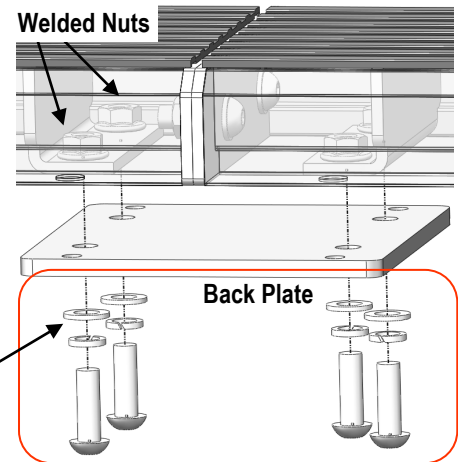

(Fig. 2) Back Plate Installation

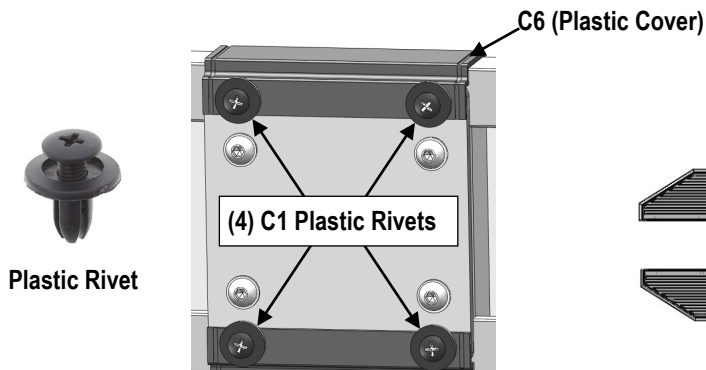

(Fig. 3) Plastic Cover Installation (Bottom View)



Assembled Step Bars



STEP 2: Passenger Rear Mounting Bracket Assembly

Assemble the Passenger Rear Mounting Bracket (**PRM+PRB**) (Fig. 4) with:

- (2) A1 (M10X1.5-30mm Hex Bolts)
- (4) A2 (M10 Large Flat Washers)
- (2) A3 (M10 Lock Washers)
- (2) A4 (M10X1.5 Hex Nuts)

NOTE: Do not fully tighten hardware at this time.

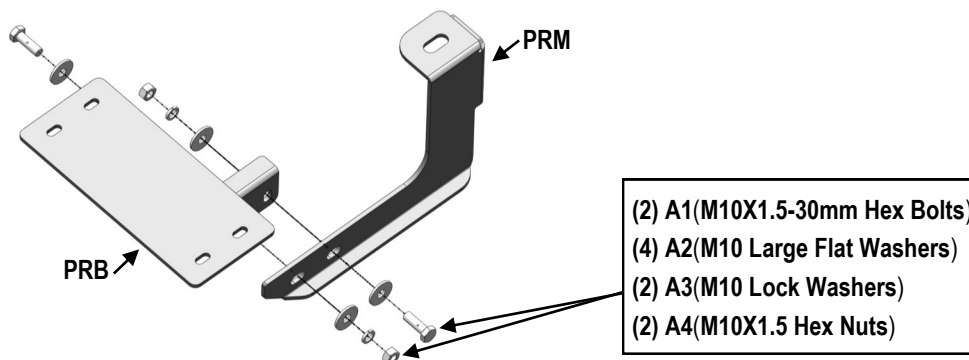

(Fig. 4) Passenger Rear Mounting Bracket Assembly

STEP 3: Install Passenger Front Mounting Bracket

1. Start the installation from the passenger side of the vehicle. Remove the front body mount bolt (Fig. 5).

NOTE: Do not remove rubber bushings.

2. Attach the Passenger Front Mounting Bracket to the body mount reusing the factory hex bolt (Fig. 6).

NOTE: Do not tighten hardware at this time.

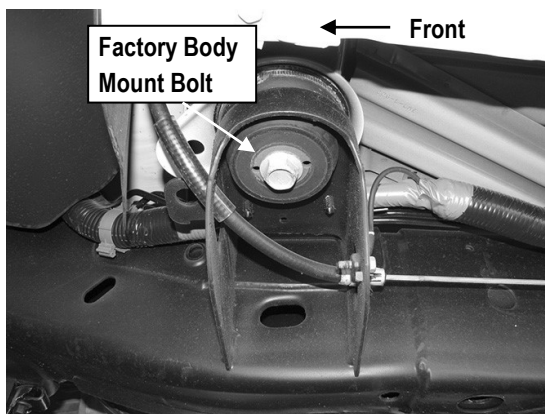

(Fig. 5) Passenger Side Front Mounting Location (Typical)

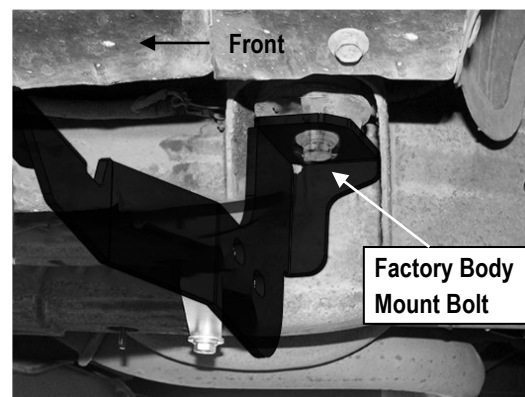

(Fig. 6) Passenger Front Mounting Bracket Installed (Typical)



STEP 4: Install Passenger Center & Rear Mounting Brackets

Repeat **Step 3** to install the Passenger Center Mounting Bracket (**PCM**) to the center body mounting location and Assembled Passenger Rear Mounting Bracket (**PRM+PRB**) to the center body mounting location.

NOTE: Do not fully tighten hardware at this time.

STEP 5: Install Passenger Side Step Bar

Once all (3) Passenger side mounting brackets are installed, then proceed to the Step Bar installation. (Figs. 7 & 8)

- Select (1) B4 (Slider) and (2) B1 (M8X1.25-35mm Carriage Bolts);
- Install (2) B1 (M8X1.25-35mm Carriage Bolts) in (1) Slider.
- Slide the Slider (with carriage bolts) to the Step Bar.
- Repeat to install the other (2) B4 (sliders) to the step bar.

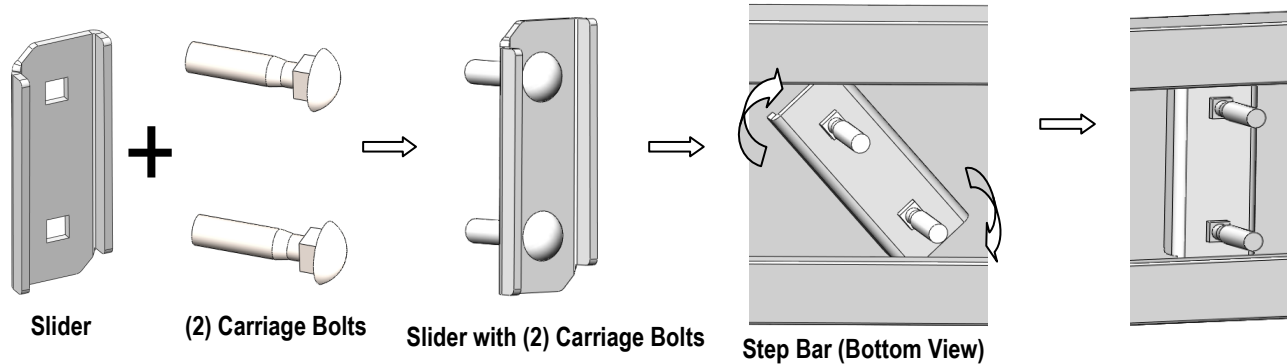

(Fig. 7) Slider Installation

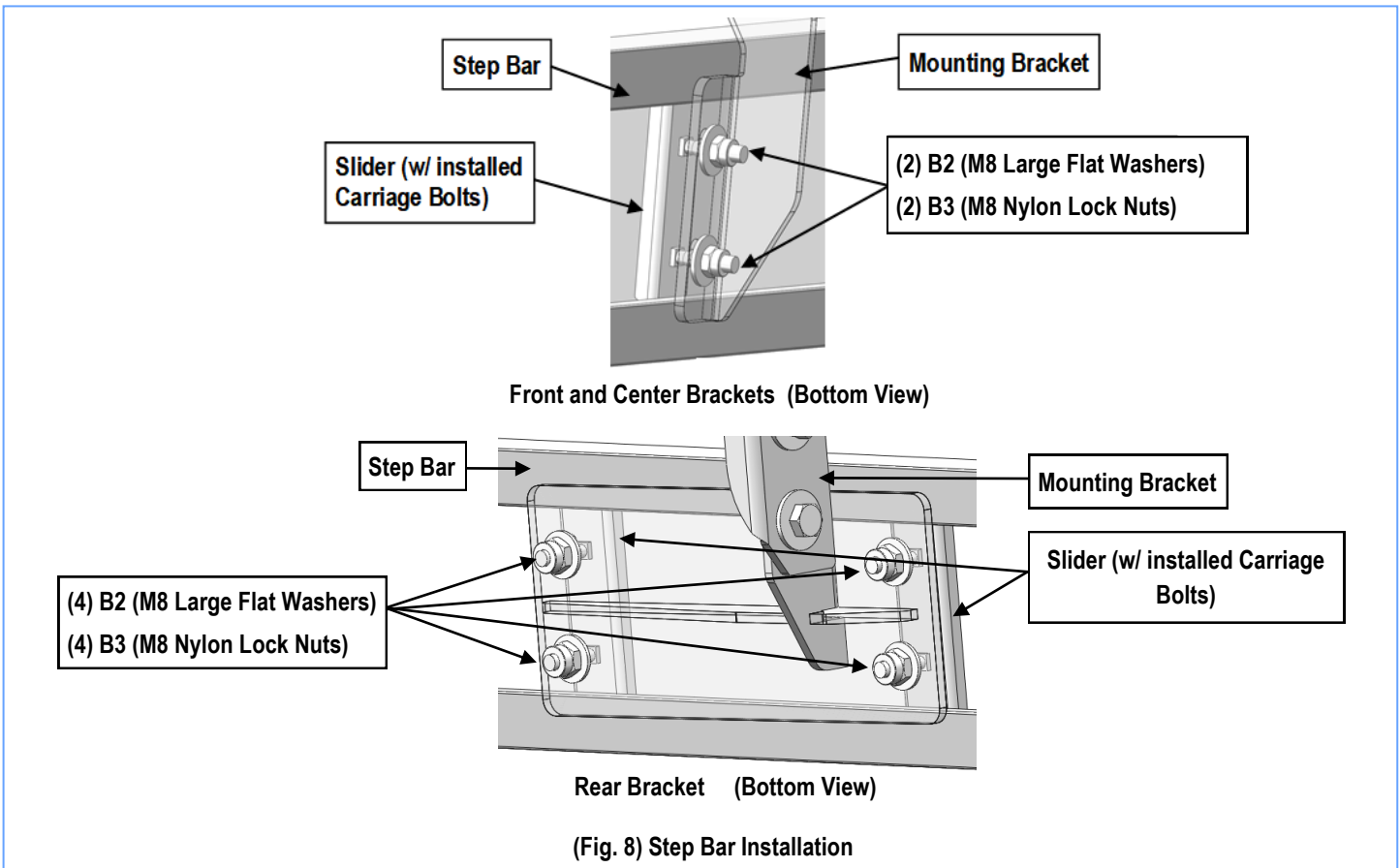

STEP 6: Passenger Side Step Bar Adjustment

- Level and adjust the assembled Step Bar properly.
- Tighten all 8mm hardware to 16-18 ft-lbs and 10mm hardware to 31-32 ft-lbs.

STEP 7: The Other Side Step Bar Installation

Move to the other side of the vehicle. Repeat **Steps 2-6** for the other side step bar installation.

Attention

- Inspect the installation periodically to make sure that all hardware is secure and tight.
- In order to protect your bars/boards, please use mild soap/non-abrasive products for cleaning only.