

iArmor[®]

IARMOR EDGE™

PART#: IA-N098H

BEFORE INSTALLATION

REMOVE CONTENTS FROM BOX. VERIFY ALL PARTS ARE PRESENT. READ INSTRUCTIONS CAREFULLY BEFORE STARTING INSTALLATION. ASSISTANCE IS RECOMMENDED. THANK YOU FOR CHOOSING OUR PRODUCT!

*ROCKER PANEL MOUNT

*DRILLING NOT REQUIRED

Torque Value

Fastener Size	Tightening Torque (ft-lbs)	Required
6mm	6-7	√
8mm	16-18	√
10mm	31-32	X
12mm	56-58	X
14mm	92-94	X

PART LIST

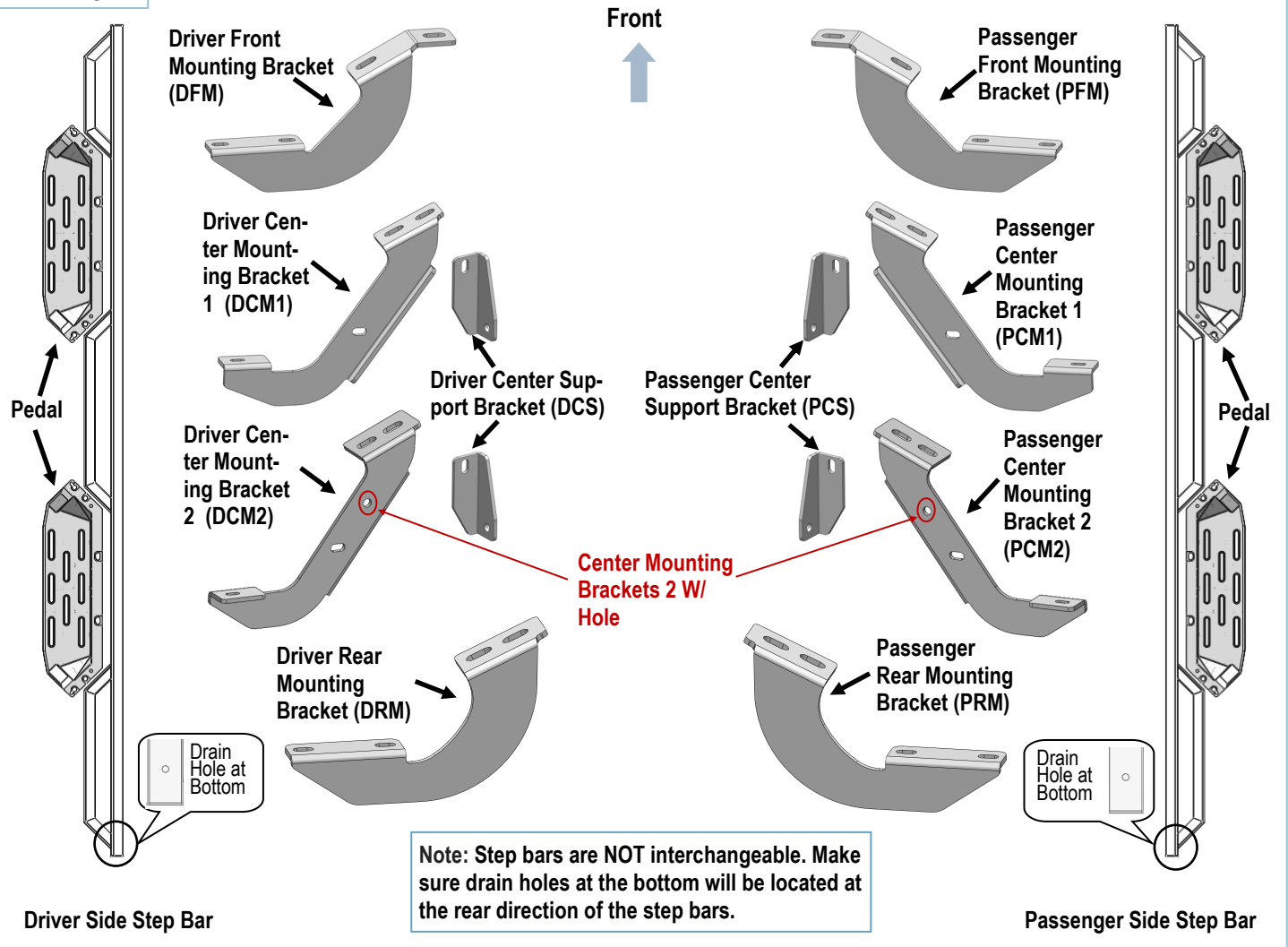

Customer Support: info@iarmorauto.com

iArmor[®]

Hardware Package A (For Brackets & Bars Installation)					
Item	QTY	Description	Item	QTY	Description
1#	20	M8X1.25-30 Hex Bolts	6#	4	M6 Large Flat Washers
2#	36	M8 Large Flat Washers	7#	4	M6 Nylon Lock Nuts
3#	20	M8 Lock Washers	8#	12	M8X1.25-20 T-Bolts
4#	4	M8 Hex Nuts	9#	12	M8 Plastic Washers
5#	4	M6X1-20 Square Head Bolts	10#	12	M8 Nylon Lock Nuts

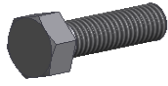

1 #



2 #



3 #



4 #



5 #



6 #



7 #



8 #



9 #



10 #

Hardware Package B (For Step Pedals Installation)					
Item	QTY	Description	Item	QTY	Description
1#	24	M8X1.25-25 Hex Bolts	3#	24	M8 Lock Washers
2#	24	M8 Large Flat Washers			

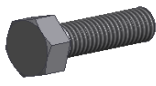

1#



2#



3#

Customer Support: info@iarmorauto.com

iArmor®

The instruction here is for your reference only. We strongly recommend the professional installer for best result. We are not responsible for any damage caused by the installation.

STEP 1

Install (4) Pedals onto the step bars with (24) M8X1.25-25mm Hex Bolts, (24) M8 Large Flat Washers and (24) M8 Lock Washers.

IMPORTANT: Don't punch the pedal with any metal hammer within pedal installation, or the pedal will be damaged.

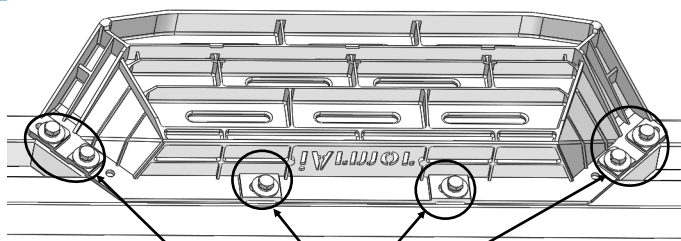

(6) M8X1.25-25 Hex Bolts
(6) M8 Large Flat Washers
(6) M8 Lock Washers

STEP 2

Start the installation from the driver side front of the vehicle, remove the plastic plugs or hex bolts covering the (2) threaded holes in the body panel, if equipped (Fig 1).

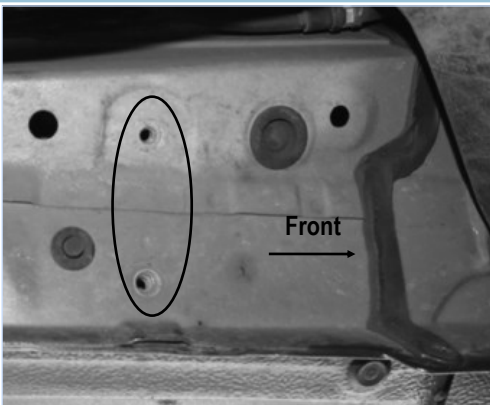

(Fig 1) Driver Side Front Mounting Location

STEP 3

Select the Driver front Mounting Bracket (**DFM**). Attach the Bracket to the vehicle using the included (2) M8X1.25-30 Hex Bolts, (2) M8 Lock Washers and (2) M8 Large Flat Washers, (Fig 2). Do not fully tighten hardware at this time.

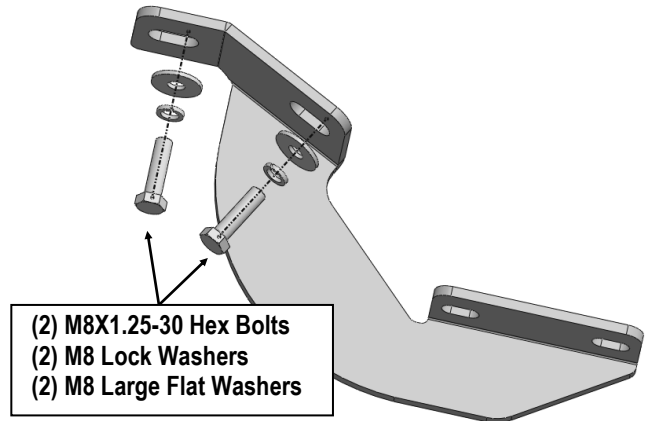

(Fig 2) Driver Front Mounting Bracket Installation

STEP 4

Assemble the Driver Center Mounting Bracket (**DCM1**) and (1) Driver Center Support Bracket (**DCS**) with (1) M8X1.25-30 Hex Bolt, (2) M8 Large Flat Washers, (1) M8 Lock Washer and (1) M8X1.25 Hex Nut, (Fig 3). ***Repeat to assemble DCM2 and DCS. Do not fully tighten hardware at this time.**

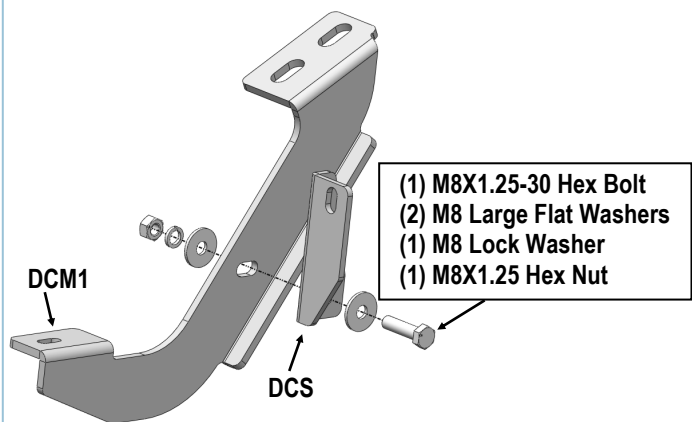

(Fig 3) Driver Center Mounting Bracket 1 Assembly

iArmor®

STEP 5

Move to the Next mounting location; Install the assembled Driver Center Mounting Bracket 1, with (2) M8X1.25-30 Hex Bolts, (2) M8 Large Flat Washers and (2) M8 Lock Washers, (Figs 4 & 5). Do not fully tighten hardware at this time.

***Repeat to install Driver Center Mounting Bracket 2 (DCM2) and Support bracket (DCS).**

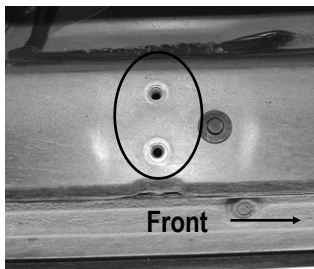

(Fig 4) Driver Side Center Mounting Location

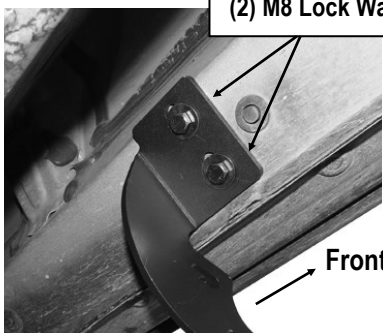

(Fig 5) Driver Center Mounting Bracket 1 Installed

STEP 6

Continue to the Rear mounting location at the back of the cab, (Fig 6). Repeat **Step 5** to install Driver Rear Mounting Bracket (DRM), (Fig 7).

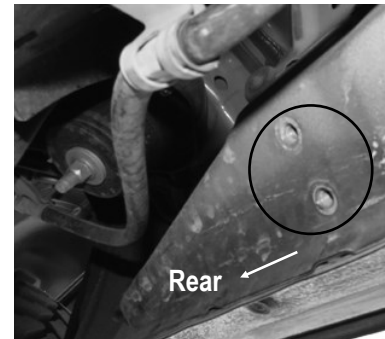

(Fig 6) Driver Side Rear Mounting Location



(Fig 7) Driver Rear Mounting Bracket Installed

STEP 7

Once all (4) brackets have been installed, select (6) M8X1.25-20mm T-Bolts, thread (1) M8 Plastic Washer on each T-Bolt, (Fig 8). Install the (6) M8X1.25-20mm T-Bolts with plastic washers in the slots on the assembled Driver side step bar. Rotate the T-Bolts to 90 degree, thread down the M8 Plastic Washers against the step bar (Fig 9).

NOTE: The Plastic Washer is designed to keep the T-Bolt in place to avoid falling into the tube during installation.

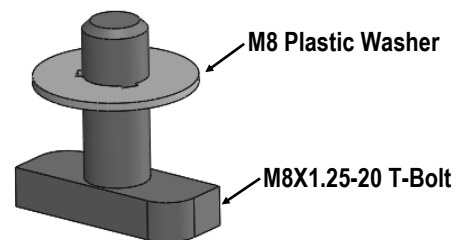

(Fig 8) Thread (1) M8 Plastic Washer on each T-Bolt Before Inserting into the slot !!!

iArmor®

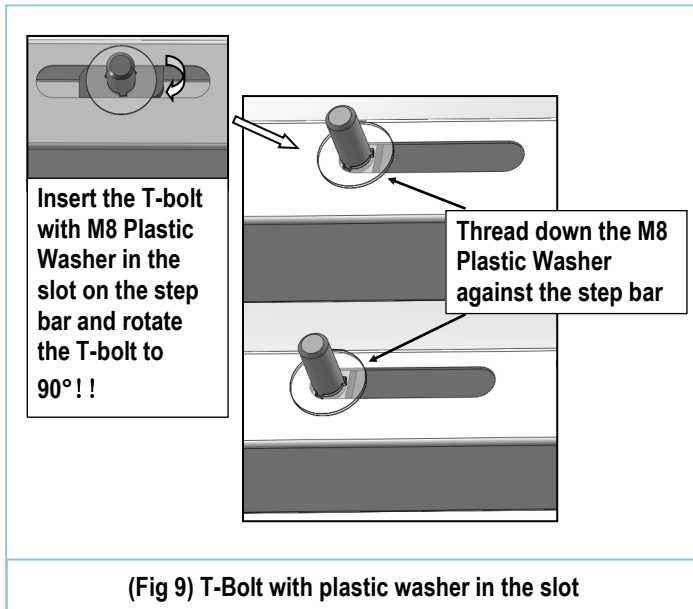

Attention

Do periodic inspections to the installation to make sure that all hardware is secure and tight.

In order to protect your bars/boards, please use mild soap/non-abrasive products for cleaning only.

STEP 8

Attach the Assembled Driver Side Step Bar onto the Mounting Brackets with (6) M8 Plastic Washers, (6) M8X1.25-20mm T-Bolts, (6) M8 Large Flat Washers, (6) M8 Nylon Lock Nuts, (Fig 10). Do not fully tighten hardware at this time.

NOTE: (2) Driver Center Mounting Brackets are located under the two pedals. Slide (2) M6X1-20mm Square Head Bolts into the channels at the bottom of pedals (Fig 11). And secure the Driver Center Mounting Brackets to the pedals with (2) M6 Large Flat Washers and (2) M6 Nylon Lock Nuts, (Fig 10). Do not fully tighten hardware at this time.

STEP 9

Level and adjust the assembled Step Bar properly and tighten all hardware.

Move to the other side of the vehicle. Repeat **Steps 2-8** for the other Side Step Bar installation.

Customer Support: info@iarmorauto.com

iArmor®

