

iArmor®

IARMOR EDGE™

PART#: IA-N097H

BEFORE INSTALLATION

REMOVE CONTENTS FROM BOX. VERIFY ALL PARTS ARE PRESENT. READ INSTRUCTIONS CAREFULLY BEFORE STARTING INSTALLATION. ASSISTANCE IS RECOMMENDED. THANK YOU FOR CHOOSING OUR PRODUCT!

*ROCKER PANEL MOUNT

*DRILLING NOT REQUIRED

Torque Value

Fastener Size	Tightening Torque (ft-lbs)	Required
6mm	6-7	√
8mm	16-18	√
10mm	31-32	X
12mm	56-58	X
14mm	92-94	X

PART LIST

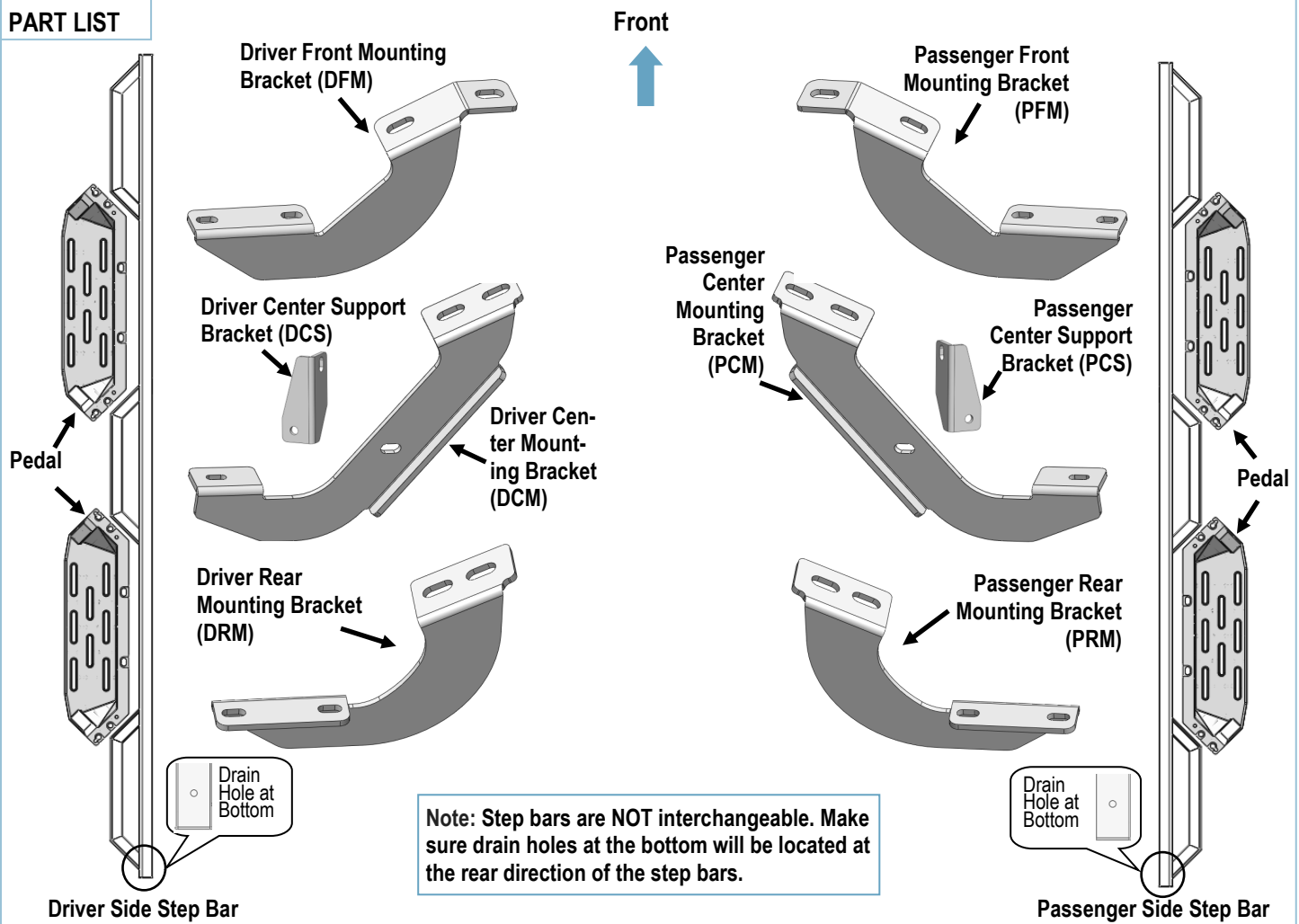

Customer Support: info@iarmorauto.com

iArmor®

Hardware Package A (For Brackets & Bars Installation)					
Item	QTY	Description	Item	QTY	Description
1#	14	M8X1.25-30mm Hex Bolts	6#	2	M6 Large Flat Washers
2#	26	M8 Large Flat Washers	7#	2	M6X1 Nylon Lock Nuts
3#	14	M8 Lock Washers	8#	10	M8X1.25-20 T-Bolts
4#	2	M8 Hex Nuts	9#	10	M8 Plastic Washers
5#	2	M6X1-20 Square Head Bolts	10#	10	M8 Nylon Lock Nuts

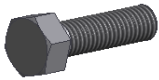

1 #



2 #



3 #



4 #

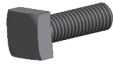

5 #



6 #



7 #



8 #



9 #



10 #

Hardware Package B (For Step Pedals Installation)					
Item	QTY	Description	Item	QTY	Description
1#	24	M8X1.25-25 Hex Bolts	3#	24	M8 Lock Washers
2#	24	M8 Large Flat Washers			

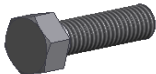

1#



2#



3#

Customer Support: info@iarmorauto.com

iArmor®

The instruction here is for your reference only. We strongly recommend the professional installer for best result. We are not responsible for any damage caused by the installation.

STEP 1

Install (4) Pedals onto the step bars with (24) M8X1.25-25mm Hex Bolts, (24) M8 Large Flat Washers and (24) M8 Lock Washers.

IMPORTANT: Don't punch the pedal with any metal hammer within pedal installation, or the pedal will be damaged.

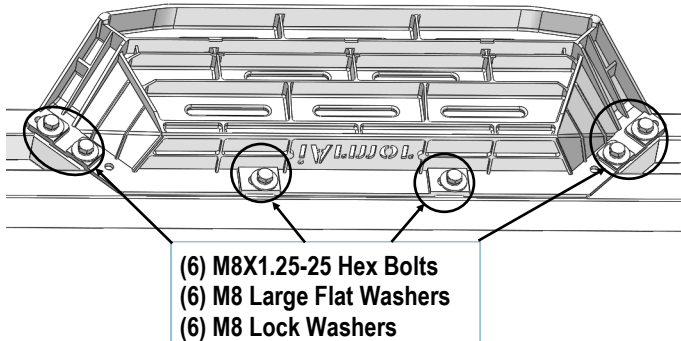

STEP 2

Start on the passenger side front of the vehicle, remove the plastic plugs or hex bolts covering the (2) threaded holes on the body panel if equipped, (Figs 1 & 2).

Remove Plastic Plugs Or Factory Hex Bolts (If Equipped)

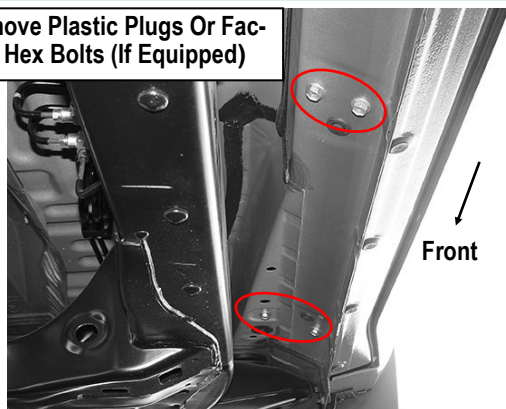

(Fig 1) Passenger Side Front & Center Mounting Location

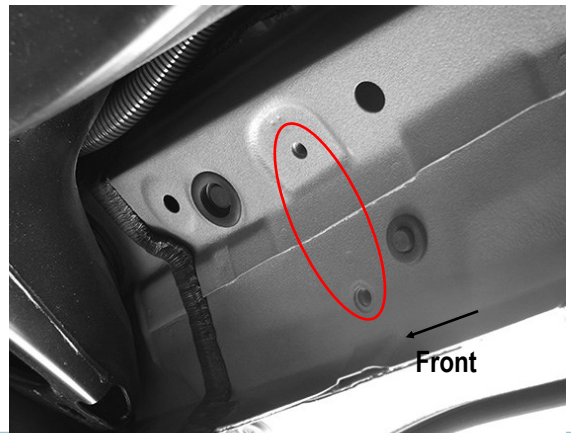

(Fig 2) Passenger Side Front Mounting Location

STEP 3

Select the Passenger Front Mounting Bracket (PFM). Attach the bracket to the vehicle using the included (2) M8X1.25-30 Hex Bolts, (2) M8 Lock Washers and (2) M8 Large Flat Washers, (Fig 3). Do not fully tighten hardware at this time.

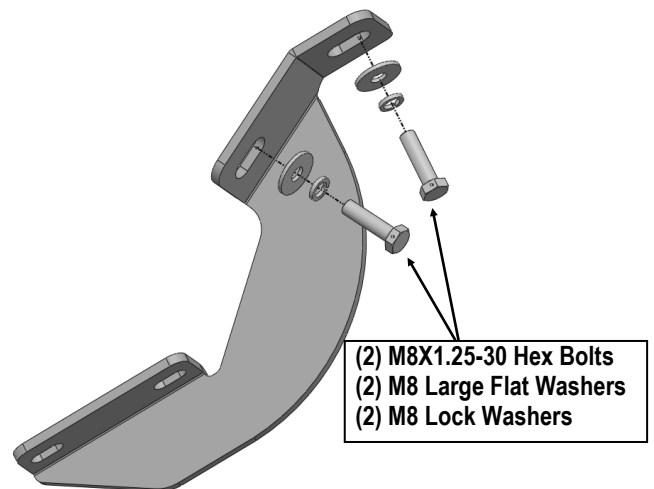

(Fig 3) Passenger Front Mounting Bracket Installation

iArmor[®]

STEP 4

Move to passenger side center mounting location, (Figs 1 & 4).

NOTE: The Tundra has (4) mounting locations along the bottom of the body. Installation will use the 1st, 2nd and 4th mounting locations only for the Mounting Brackets.

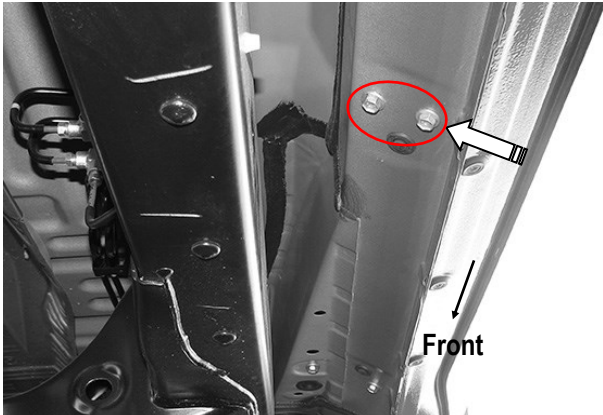

(Fig 4) Passenger Side Center Mounting Location

STEP 5

Assemble the Passenger Center Mounting Bracket (PCM) and Passenger Center Support Bracket (PCS) with (1) M8X1.25-30 Hex Bolt, (2) M8 Large Flat Washers, (1) M8 Lock Washer and (1) M8X1.25 Hex Nut, (Fig 5). Do not fully tighten at this time.

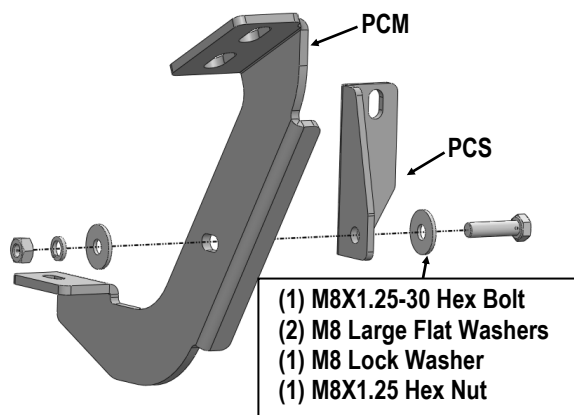

(Fig 5) Passenger Center Mounting Bracket Assembly

STEP 6

Install the Passenger Center Mounting Bracket on the vehicle with (2) M8X1.25-30 Hex Bolts, (2) M8 Lock Washers and (2) M8 Large Flat Washers, (Fig 6). Do not fully tighten at this time.

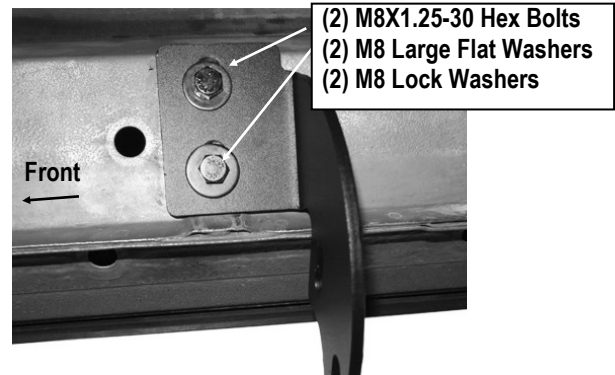

(Fig 6) Passenger Center Bracket Installed

STEP 7

Move to the last mounting location at the back of the cab, (Fig 7). Repeat **Step 3** to install the Passenger Side Rear Bracket with (2) M8X1.25-30 Hex Bolts, (2) M8 Lock Washers and (2) M8 Large Flat Washers, (Fig 8).

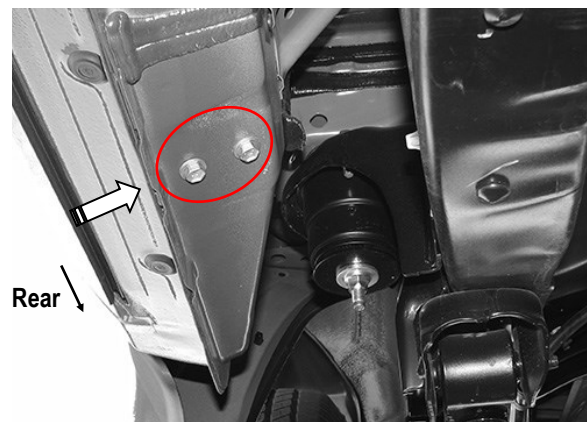

(Fig 7) Passenger Side Rear Mounting Location

iArmor®

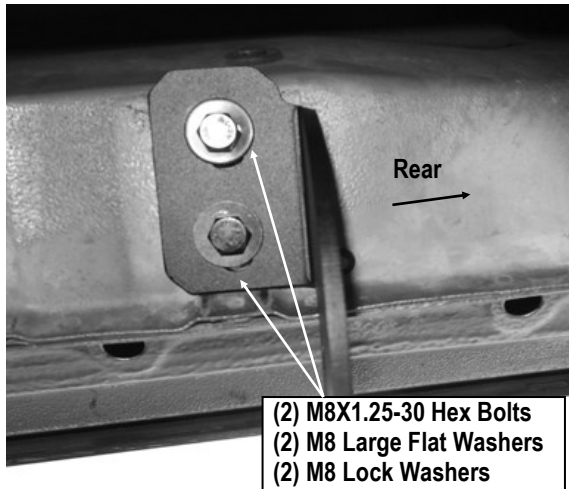

(Fig 8) Passenger Rear Mounting Bracket Installed

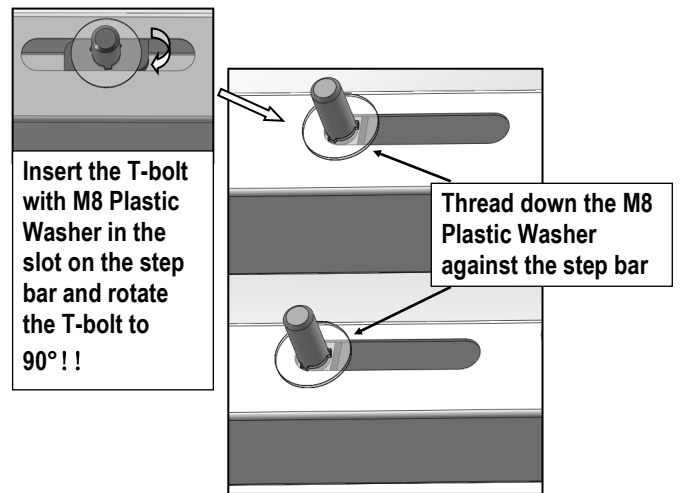

(Fig 10) T-Bolt with plastic washer in the slot

STEP 8

Once all (3) brackets have been installed, select (5) M8X1.25-20mm T-Bolts, thread (1) M8 Plastic Washer on each T-Bolt, (Fig 9). Install the (5) M8X1.25-20mm T-Bolts with plastic washers in the slots on the assembled Passenger side step bar. Rotate the T-Bolts to 90 degree, thread down the M8 Plastic Washers against the step bar (Fig 10).

NOTE: The Plastic Washer is designed to keep the T-Bolt in place to avoid falling into the tube during installation.

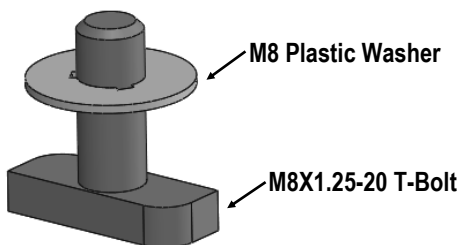

(Fig 9) Thread (1) M8 Plastic Washer on each T-Bolt Before Inserting into the slot !!!

STEP 9

Attach the Assembled Passenger Side Step Bar onto the Mounting Brackets with (5) M8 Plastic Washers, (5) M8X1.25-20mm T-Bolts, (5) M8 Large Flat Washers, (5) M8 Nylon Lock Nuts, (Fig 11). Do not fully tighten hardware at this time.

NOTE: the Passenger Center Mounting Bracket is located under the front pedal. Slide (1) M6X1-20mm Square Head Bolt into the channel at the bottom of the front pedal (Fig 12). And secure the Passenger Center Mounting Bracket to the pedal with (1) M6 Large Flat Washer and (1) M6 Nylon Lock Nut, (Fig 11). Do not fully tighten hardware at this time.

STEP 10

Level and adjust the assembled Step Bar properly and tighten all hardware.

Move to the other side of the vehicle. Repeat **Steps 2-9** for the other Side Step Bar installation.

iArmor®

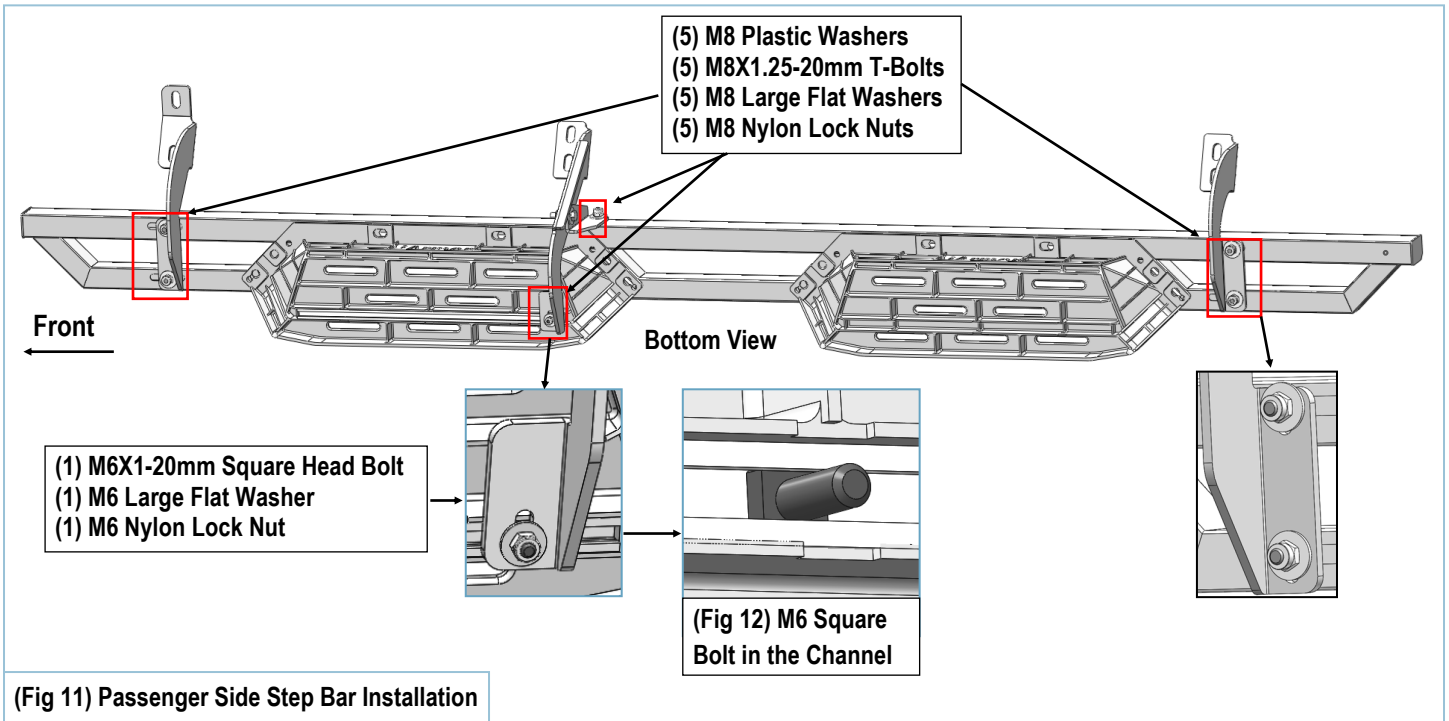

Attention

Do periodic inspections to the installation to make sure that all hardware is secure and tight.
In order to protect your bars/boards, please use mild soap/non-abrasive products for cleaning only.