

# iArmor®

## IARMOR EDGE™

PART#: IA-N056

### BEFORE INSTALLATION

REMOVE CONTENTS FROM BOX. VERIFY ALL PARTS ARE PRESENT. READ INSTRUCTIONS CAREFULLY BEFORE STARTING INSTALLATION. ASSISTANCE IS RECOMMENDED. THANK YOU FOR CHOOSING OUR PRODUCT!

**\*DRILLING NOT REQUIRED**

**\*TRIMMING NOT REQUIRED**

### Torque Value

Fastener Size	Tightening Torque (ft-lbs)
6mm	6-7
8mm	16-18
10mm	31-32
12mm	56-58
14mm	92-94

### PART LIST

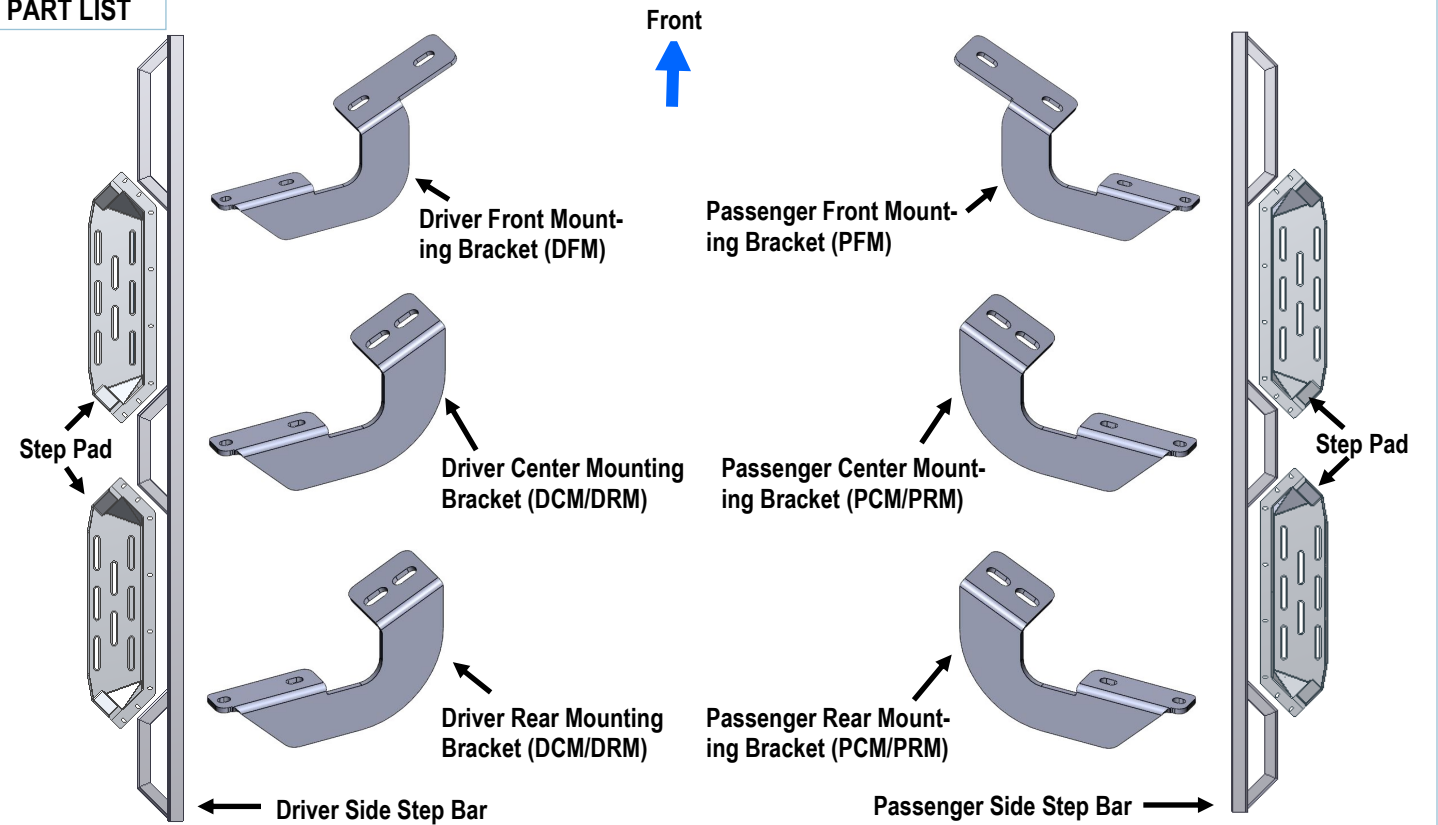

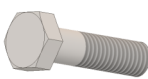
 X12  
M8X1.25-30 Hex Bolt

 X12  
M8 Flat Washer

 X12  
M8 Lock Washer

 X44  
M6X1-20 T-Bolt

 X44  
M6 Large Flat Washer

 X44  
M6X1 Nylon Lock Nut

 X8  
M6X1-20 Flat Sunk Bolt

Customer Support: [info@iarmorauto.com](mailto:info@iarmorauto.com)

# iArmor®

The instruction here is for your reference only. We strongly recommend the professional installer for best result. We are not responsible for any damage caused by the installation.

## STEP 1

Install the Step Pads onto the step bars with (32) M6X1-20 T-Bolts, (32) M6 Large Flat Washers, (32) M6X1Nylon Lock Nuts and (8) M6X1-20 Flat sunk head bolts.

**IMPORTANT:** Don't hit the step pad by any metal hammer with-in step pad installation, or the step pad will be damaged.

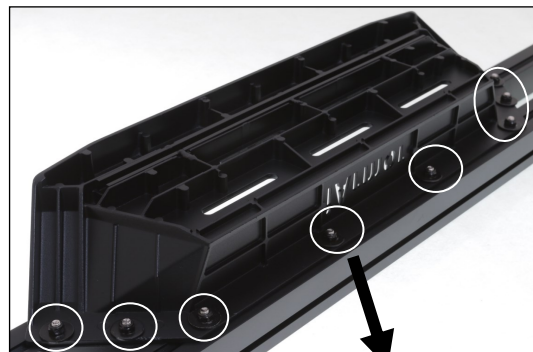
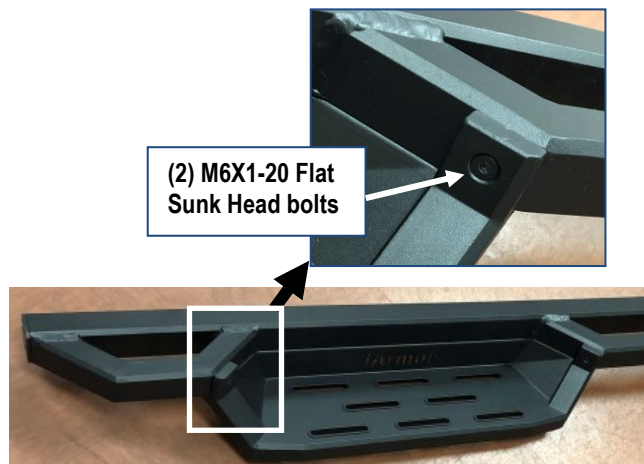

- (8) M6X1-20 T-Bolts
- (8) M6 Large Flat Washers
- (8) M6X1Nylon Lock Nuts



## STEP 2

Starting from the Passenger Side Front of the vehicle, remove the plastic plugs or bolts covering the threaded holes in the rocker panel, (Fig 1).

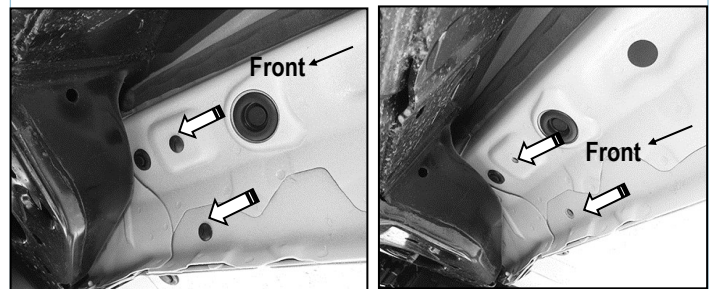

(Fig 1) Remove plastic plugs or factory hex bolts (If equipped) (Passenger Side Front Mounting Location)

## STEP 3

Attach the Passenger Front Mounting Bracket (PFM) to the vehicle with (2) M8X1.25-30 Hex Bolts, (2) M8 Lock Washers and (2) M8 Flat Washers, (Fig 2). Do not fully tighten hardware at this time.

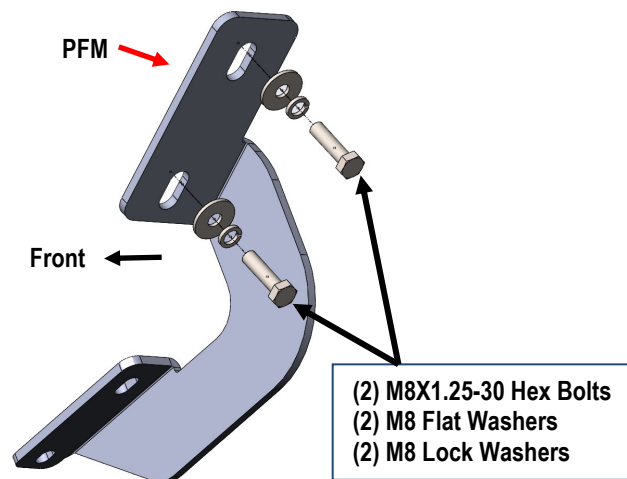

(Fig 2) Passenger Front Mounting Bracket (PFM) Installed

# iArmor®

## STEP 4

Move to the Passenger Side Center Mounting location. Attach the Passenger Center Mounting Bracket (PCM/PRM) to the rocker panel with (2) M8X1.25-30 Hex Bolts, (2) M8 Lock Washers and (2) M8 Flat Washers, (Fig 3 & 4). Do not fully tighten hardware at this time.

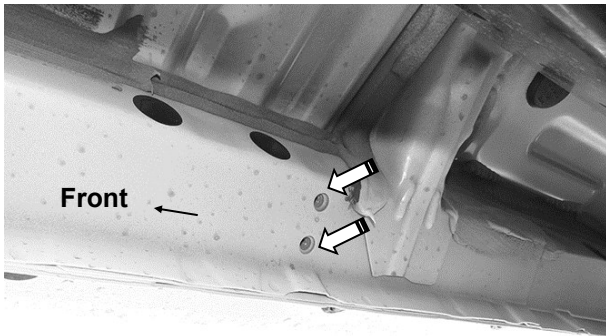

(Fig 3) Passenger Side Center Mounting Location

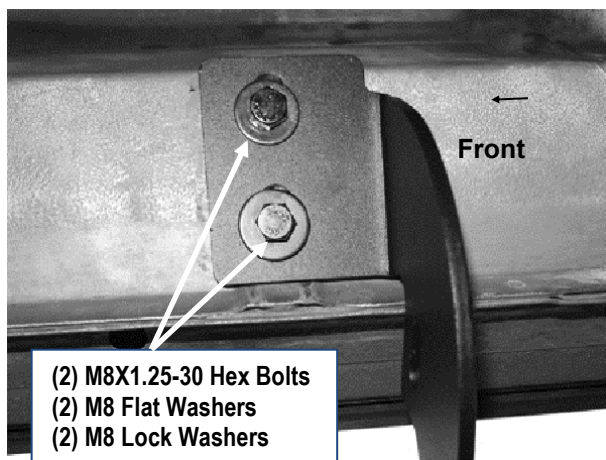

(Fig 4) Passenger Center Mounting Bracket (PCM/PRM) Installed

## STEP 5

Move to the Passenger Side Rear Mounting location. Repeat Step 4 to install Passenger Rear Mounting Bracket (PCM/PRM), (Fig 5 & 6). Do not fully tighten hardware at this time.

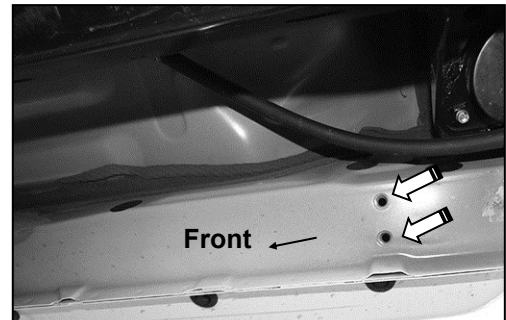

(Fig 5) Passenger Side Rear Mounting Location

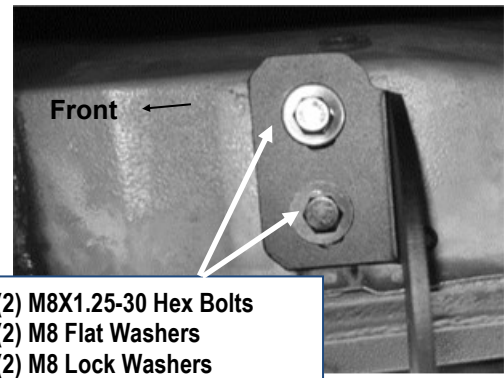

(Fig 6) Passenger Rear Mounting Bracket (PCM/PRM) Installed

## STEP 6

Once (3) passenger side mounting brackets are installed, attach the Assembled Passenger Side Step Bar onto the mounting brackets with (6) M6X1-20 T-Bolts, (6) M6 Large Flat Washers and (6) M6X1 Nylon Lock Nuts, (Fig 7). Do not fully tighten hardware.

# iArmor®

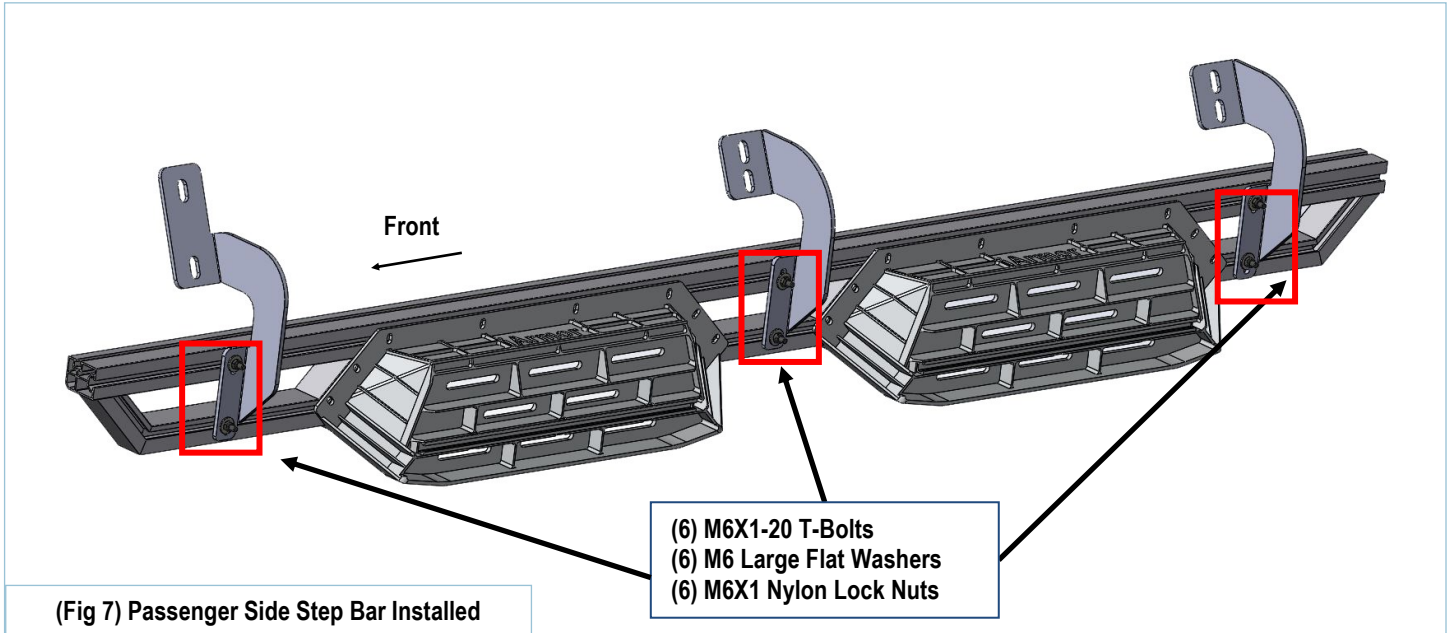

## STEP 7

Level and adjust the step bar properly and tighten all hardware.

## STEP 8

Move to the driver side of the vehicle. Repeat **steps 2-7** to install the driver side step bar.

### Attention

Do periodic inspections to the installation to make sure that all hardware is secure and tight.

In order to protect your bars/boards, please use only mild soap/non-abrasive products for cleaning.