

iArmor[®]

IARMOR EDGE™

PART#: IA-N297H

BEFORE INSTALLATION

REMOVE CONTENTS FROM BOX. VERIFY ALL PARTS ARE PRESENT. READ INSTRUCTIONS CAREFULLY BEFORE STARTING INSTALLATION. ASSISTANCE IS RECOMMENDED. THANK YOU FOR CHOOSING OUR PRODUCT!

*ROCKER PANEL MOUNT

*DRILLING NOT REQUIRED

Torque Value

Fastener Size	Tightening Torque (ft-lbs)	Required
6mm	6-7	√
8mm	16-18	√
10mm	31-32	X
12mm	56-58	X
14mm	92-94	X

PART LIST

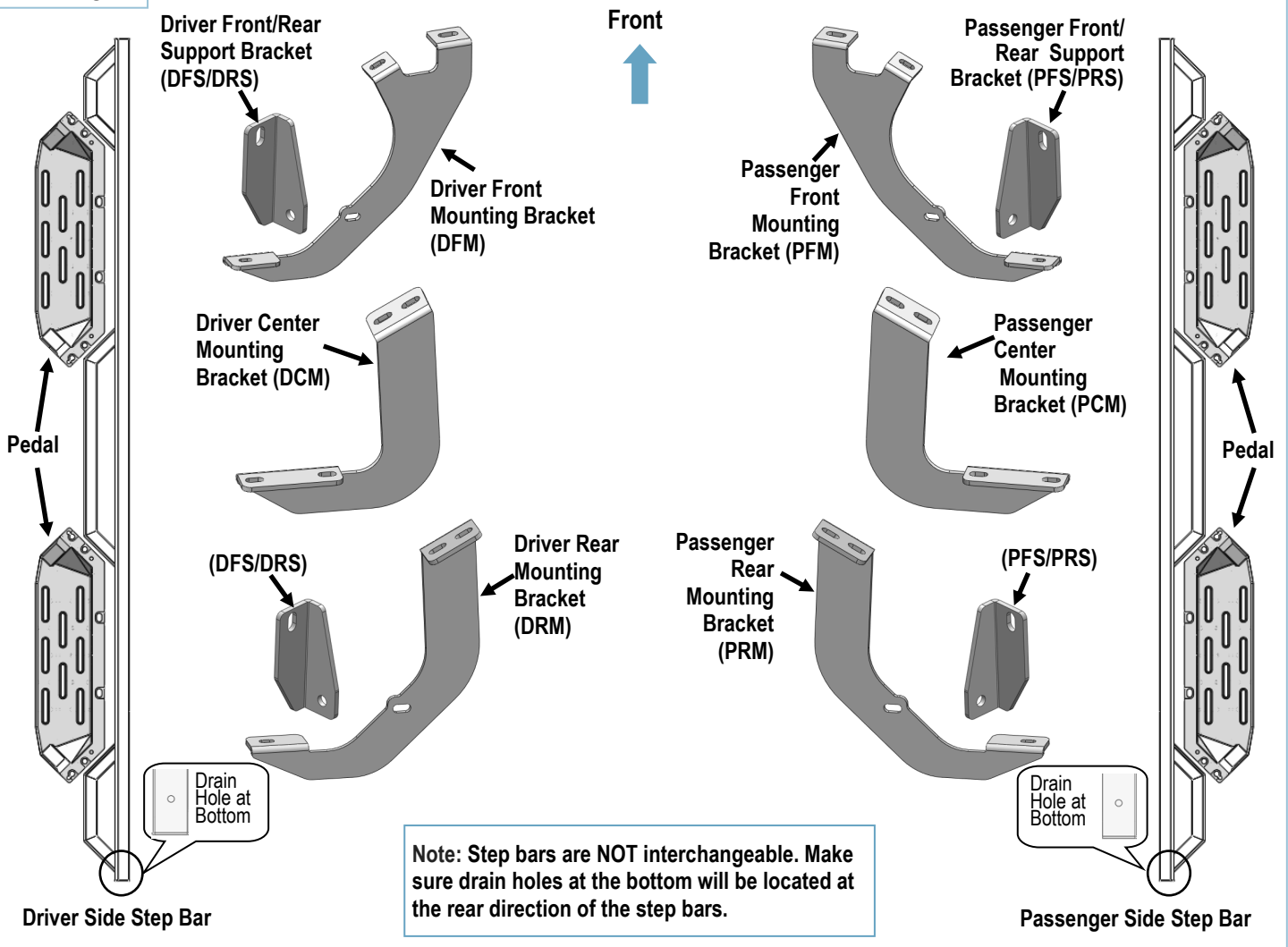

Customer Support: info@iarmorauto.com

iArmor[®]

Hardware Package A (For Brackets & Bars Installation)					
Item	QTY	Description	Item	QTY	Description
1#	12	M8X1.25-30mm Hex Bolts	6#	4	M6X1-20 Square Head Bolts
2#	4	M8X1.25-25mm Hex Bolts	7#	4	M6 Large Flat Washers
3#	28	M8 Large Flat Washers	8#	4	M6 Nylon Lock Nuts
4#	12	M8 Lock Washers	9#	8	M8X1.25-20 T-Bolts
5#	12	M8X1.25 Nylon Lock Nuts	10#	8	M8 Plastic Washers

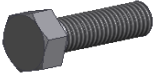

1 #

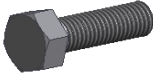

2 #



3 #



4 #



5 #

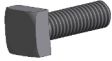

6 #



7 #



8 #



9 #



10 #

Hardware Package B (For Step Pedals Installation)					
Item	QTY	Description	Item	QTY	Description
1#	24	M8X1.25-25 Hex Bolts	3#	24	M8 Lock Washers
2#	24	M8 Large Flat Washers			

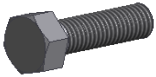

1#



2#



3#

Customer Support: info@iarmorauto.com

iArmor®

The instruction here is for your reference only. We strongly recommend the professional installer for best result. We are not responsible for any damage caused by the installation.

STEP 1

Install (4) Pedals onto the step bars with (24) M8X1.25-25mm Hex Bolts, (24) M8 Large Flat Washers and (24) M8 Lock Washers.

IMPORTANT: Don't punch the pedal with any metal hammer within pedal installation, or the pedal will be damaged.

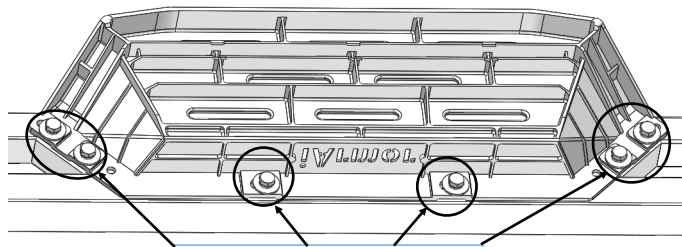

- (6) M8X1.25-25 Hex Bolts
- (6) M8 Large Flat Washers
- (6) M8 Lock Washers

STEP 2

Assemble Passenger Front Mounting Bracket (PFM) and Passenger Front Support Bracket (PFS/PRS) with (1) M8X1.25-25mm Hex Bolt, (2) M8 Large Flat Washers, (1) M8 Nylon Lock Nut (Fig 2). Do not fully tighten at this time.

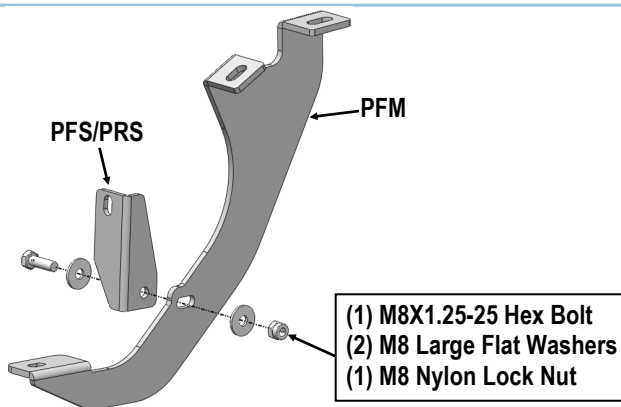

(Fig 1) Passenger Front Brackets Assembly

STEP 3

Start from the passenger side front of the vehicle. Remove the plastic plugs or hex bolts if equipped, (Fig 1).

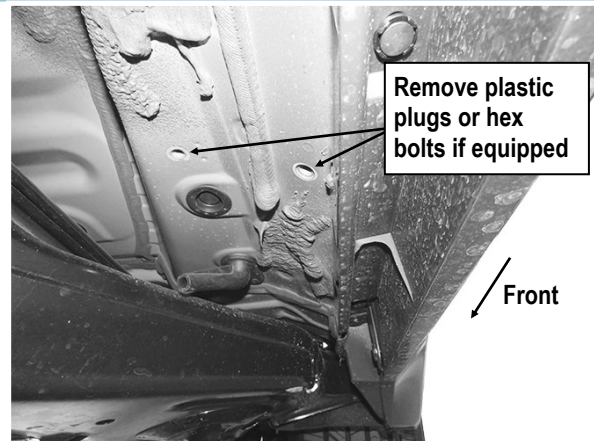

(Fig 2) Passenger Side Front Mounting Location

STEP 4

Attach the Assembled Passenger Front Brackets to the mounting location with (2) M8X1.25-30 Hex Bolts, (2) M8 Lock Washers and (2) M8 Large Flat Washers, (Fig 3). Do not fully tighten at this time.

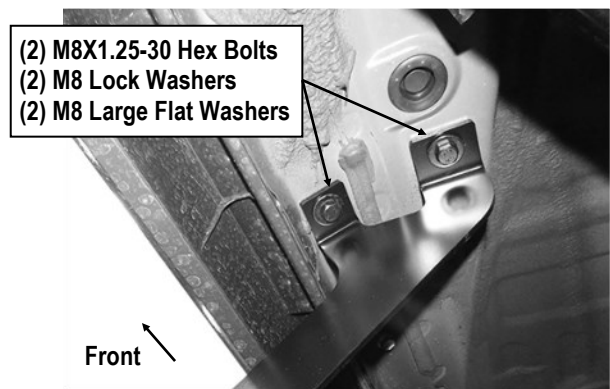

(Fig 3) Passenger Front Mounting Bracket Installed

iArmor®

STEP 5

Repeat **Step 4** to install Passenger Center Mounting Bracket (PCM), (Figs 4-5). Do not fully tighten at this time.

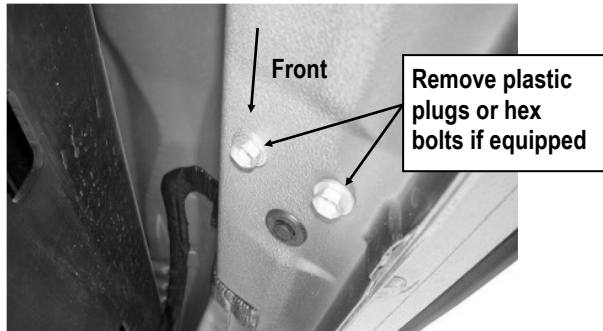

(Fig 4) Passenger Side Center / Rear Mounting Location

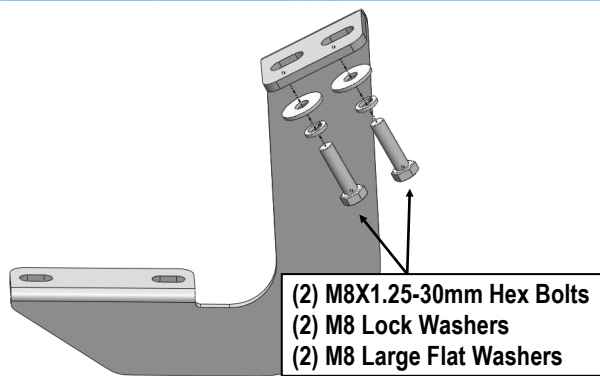

(Fig 5) Passenger Center Mounting Bracket Installation

STEP 6

Repeat **Step 2** to assemble Passenger Rear Mounting Bracket (PRM) and Passenger Rear Support Bracket (PFS/PRS). Do not fully tighten at this time.

Repeat **Step 4** to install Passenger Rear Mounting Brackets to the Rear Mounting Location. Do not fully tighten at this time.

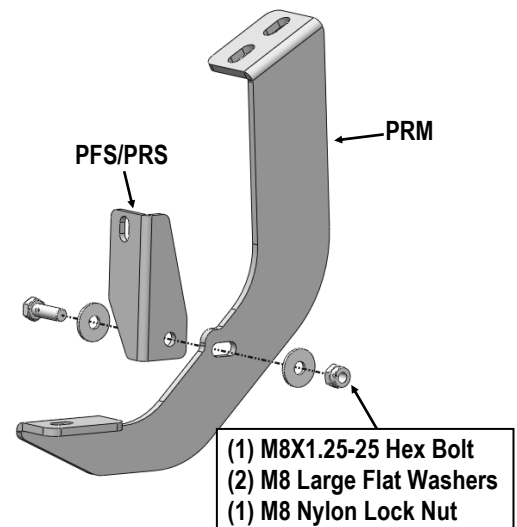

(Fig 6) Passenger Rear Brackets Assembly

STEP 7

Once all (3) brackets have been installed, select (4) M8X1.25-20mm T-Bolts, thread (1) M8 Plastic Washer on each T-Bolt, (Fig 7). Install the (4) M8X1.25-20mm T-Bolts with plastic washers in the slots on the assembled Passenger side step bar. Rotate the T-Bolts to 90 degree, thread down the M8 Plastic Washers against the step bar (Fig 8).

NOTE: The Plastic Washer is designed to keep the T-Bolt in place to avoid falling into the tube during installation.

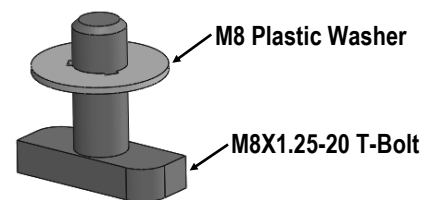

(Fig 7) Thread (1) M8 Plastic Washer on each T-Bolt Before Inserting into the slot !!!

iArmor®

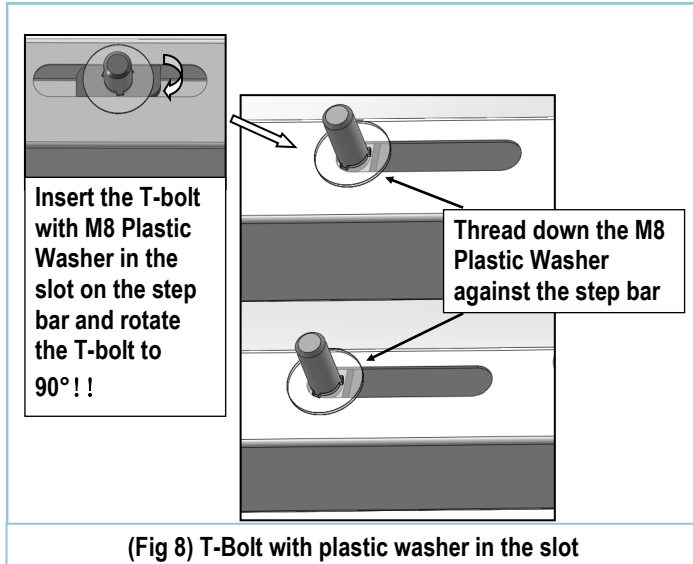

STEP 9

Level and adjust the assembled Step Bar properly and tighten all hardware.

Move to the other side of the vehicle. Repeat **Steps 2-9** for the other Side Step Bar installation.

Attention

Do periodic inspections to the installation to make sure that all hardware is secure and tight.

In order to protect your bars/boards, please use mild soap/non-abrasive products for cleaning only.

STEP 8

Attach the Assembled Passenger Side Step Bar onto the Mounting Brackets with (4) M8 Plastic Washers, (4) M8X1.25-20mm T-Bolts, (4) M8 Large Flat Washers, (4) M8 Nylon Lock Nuts, (**Fig 9**). Do not fully tighten hardware at this time.

NOTE: Passenger Front & Rear Mounting Brackets are located under (2) pedals. Slide (2) M6X1-20mm Square Head Bolts into the channels at the bottom of pedals (**Fig 10**). And secure the Passenger Front & Rear Mounting Brackets to the pedals with (2) M6 Large Flat Washers and (2) M6 Nylon Lock Nuts, (**Fig 9**). Do not fully tighten hardware at this time.

iArmor[®]

