

iArmor[®]

iArmor[®] by APS

PART#: IA-S010H

BEFORE INSTALLATION

REMOVE CONTENTS FROM BOX. VERIFY ALL PARTS ARE PRESENT. READ INSTRUCTIONS CAREFULLY BEFORE STARTING INSTALLATION. ASSISTANCE IS RECOMMENDED. THANK YOU FOR CHOOSING OUR PRODUCT!

*ROCKER PANEL MOUNT

*DRILLING NOT REQUIRED

Torque Value

Fastener Size	Tightening Torque (ft-lbs)	Required
6mm	6-7	X
8mm	16-18	√
10mm	31-32	X
12mm	56-58	X
14mm	92-94	X

PART LIST

Driver Side Step Bar

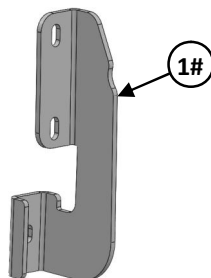
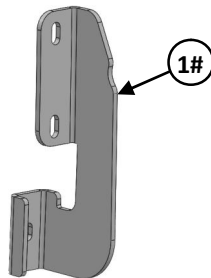
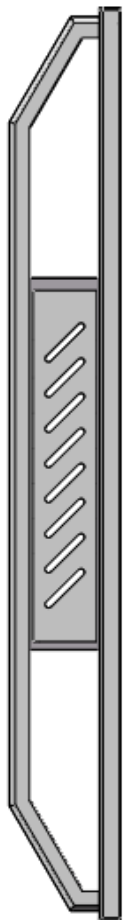

Front



Passenger Side Step Bar

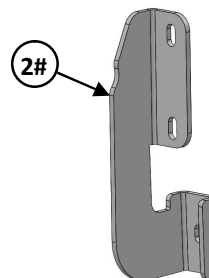
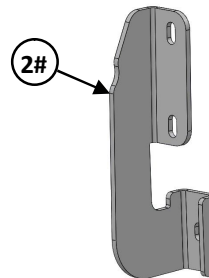
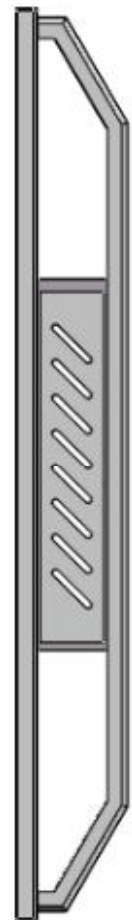

iArmor®

Hardware Package A (For Bracket Installation)					
Item	QTY	Description	Item	QTY	Description
1#	2	Driver Front / Center / Rear Mounting Brackets	5#	12	M8 Large Flat Washers
2#	2	Passenger Front / Center / Rear Mounting Brackets	6#	4	M8 Nylon Lock Nuts
3#	4	U Brackets	7#	4	M8 Clip Nuts
4#	8	M8X1.25-25mm Hex Bolts			

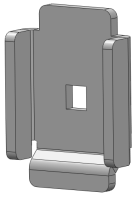

3 #



4 #



5 #



6 #

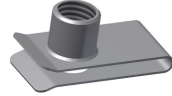

7 #

Hardware Package B (For Step Bar Installation)					
Item	QTY	Description	Item	QTY	Description
1#	4	M8X1.25-55mm Carriage Bolts	3#	4	M8 Lock Washers
2#	4	M8 Large Flat Washers	4#	4	M8 Hex Nuts

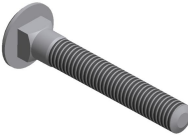

1 #



2#



3 #

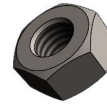

4 #

iArmor[®]

The instruction here is for your reference only. We strongly recommend the professional installer for best result. We are not responsible for any damage caused by the installation.

STEP 1

Start from the passenger side front mounting location as shown, (Fig 1). Install (1) M8 Clip Nut on mounting position as shown, (Fig 2).

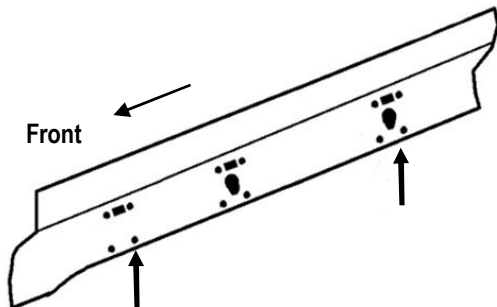

(Fig 1) Passenger Side Front Mounting Location

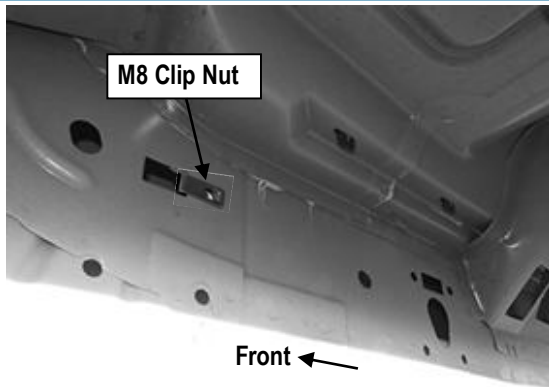

(Fig 2) Install (1) M8 Clip Nut

STEP 2

Attach the Passenger Front Mounting Bracket onto front mounting position with (1) M8 Clip Nut, (2) M8X1.25-25mm Hex Bolts, (1) M8 Lock Washer, (3) M8 Large Flat Washers and (1) M8X1.25 Nylon Lock Nut, (Fig 3). Do not fully tighten hardware at this time.

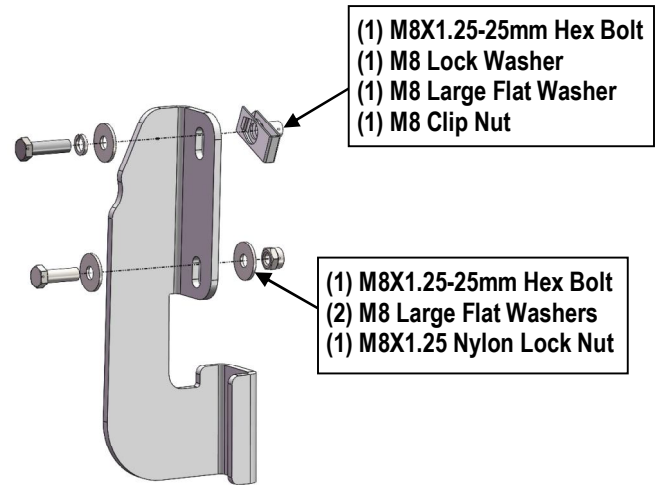

(Fig 3) Passenger Front Mounting Bracket Installation

STEP 3

Move to the passenger side rear mounting location, (Fig 4). Repeat **Steps 2-3** to install the Passenger Rear Mounting Bracket. Do not fully tighten hardware at this time.

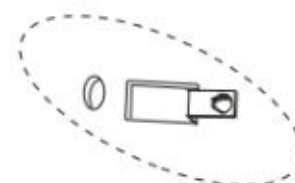
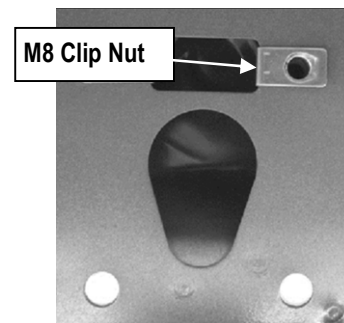

(Fig 4) Passenger Side Rear Mounting Location

iArmor®

STEP 4

Once all (2) passenger side mounting brackets are installed, select and attach the Passenger Side Step Bar onto the Mounting Brackets with (2) U Brackets, (2) M8X1.25-55mm Carriage Bolts, (2) M8 Large Flat Washers, (2) M8 Lock Washers and (2) M8X1.25 Hex Nuts, (Fig 5). Do not fully tighten hardware at this time.

STEP 5

Properly level and adjust the Step Bar and fully tighten all hardware.

STEP 6

Move to the driver side of the vehicle. Repeat **Steps 1-6** to install the driver side step bar.

Installation completed.

Attention

Do periodic inspections to the installation to make sure that all hardware is secure and tight.

In order to protect your bars/boards, please use mild soap/non-abrasive products for cleaning only.

NOTE: Torque all M8 X1.25-55mm Carriage Bolts to 16~18 lb-ft. Don't over tighten, or the square bars will be damaged by the brackets

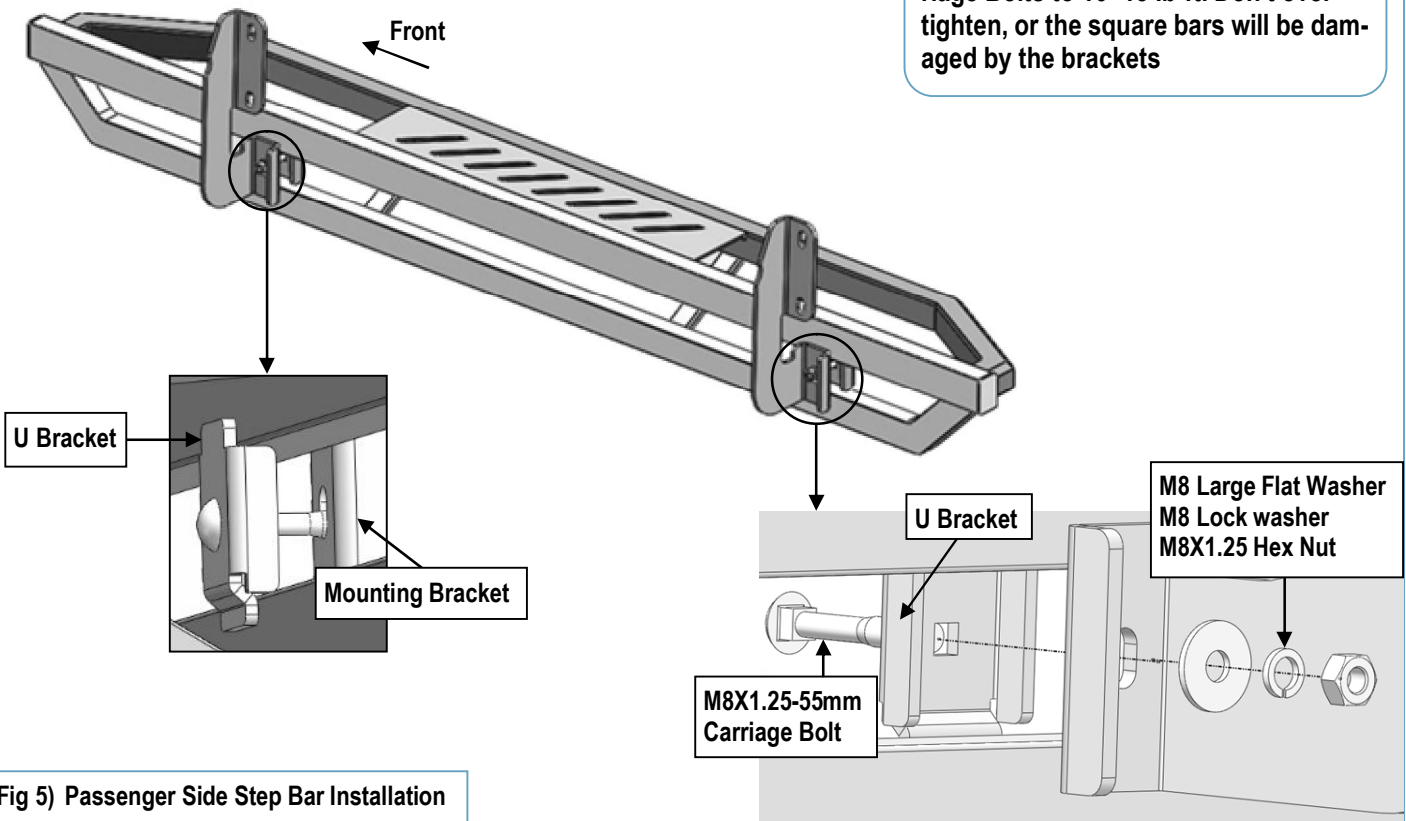

(Fig 5) Passenger Side Step Bar Installation