

# iArmor<sup>®</sup>

## iArmor<sup>®</sup> by APS

PART#: IA-S239H&S313H

### BEFORE INSTALLATION

REMOVE CONTENTS FROM BOX. VERIFY ALL PARTS ARE PRESENT. READ INSTRUCTIONS CAREFULLY BEFORE STARTING INSTALLATION. ASSISTANCE IS RECOMMENDED. THANK YOU FOR CHOOSING OUR PRODUCT!

**\*ROCKER PANEL MOUNT**

**\*NO DRILLING / TRIMMING REQUIRED**

### Torque Value

Fastener Size	Tightening Torque (ft-lbs)	Required
6mm	6-7	X
8mm	16-18	√
10mm	31-32	√
12mm	56-58	X
14mm	92-94	X

### PART LIST

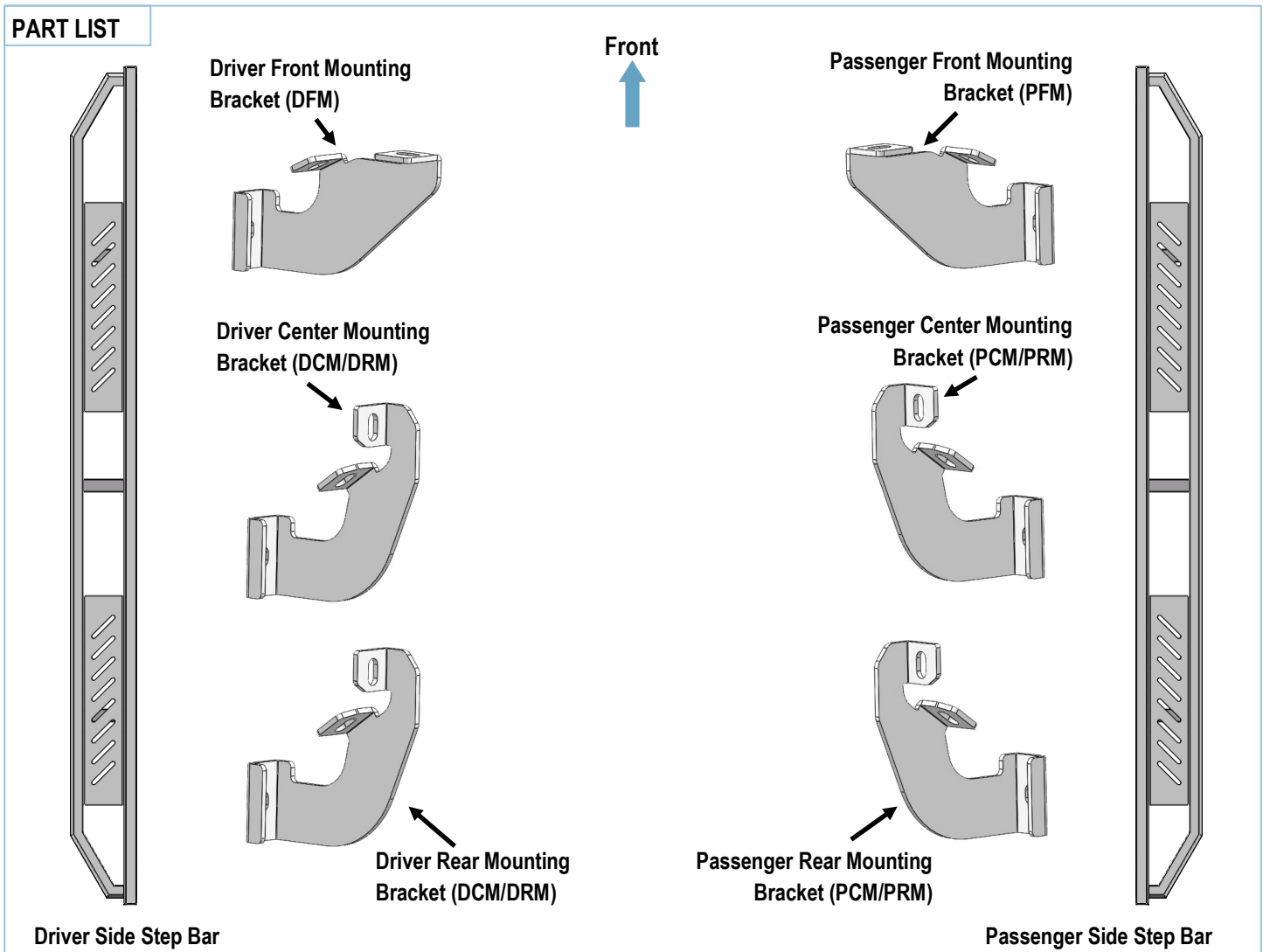

Customer Support: [info@iarmorauto.com](mailto:info@iarmorauto.com)

# iArmor®

Hardware Package A (For Bracket Installation)					
Item	QTY	Description	Item	QTY	Description
1#	6	U Brackets	3#	12	M10 Large Flat Washers
2#	12	M10X1.5-25mm Hex Bolts	4#	12	M10 Lock Washers

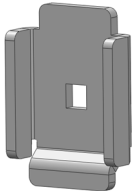

1 #

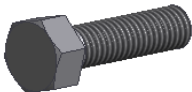

2 #



3 #



4 #

Hardware Package B (For Step Bar Installation)					
Item	QTY	Description	Item	QTY	Description
1#	6	M8X1.25-55mm Carriage Bolts	3#	6	M8 Lock Washers
2#	6	M8 Large Flat Washers	4#	6	M8 Hex Nuts

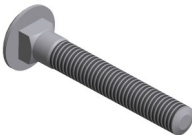

1 #



2 #



3 #

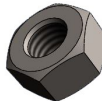

4 #

# iArmor®

The instruction here is for your reference only. We strongly recommend the professional installer for best result. We are not responsible for any damage caused by the installation.

## STEP 1

Start the installation under the Passenger side of the vehicle. Locate the front factory mounting location along the inner side of the body, (Fig 1).

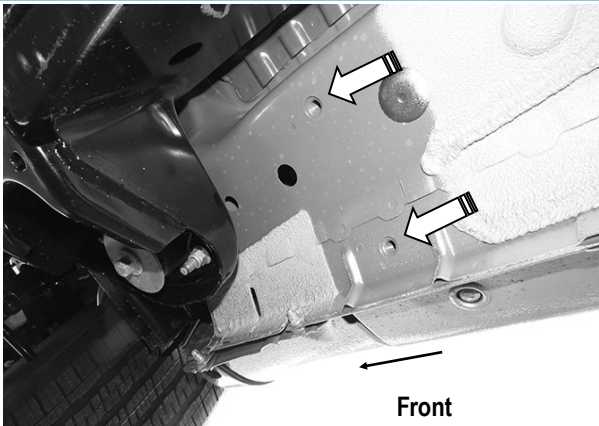

(Fig 1) Passenger Front Mounting Location

## STEP 2

Remove the plastic plugs covering the mounting holes. Select Passenger Front Mounting Bracket (PFM). Attach to Passenger front location with (2) M10x1.5-25mm Hex Bolts, (2) M10 Lock Washers and (2) M10 Large Flat Washers (Fig 2). Do not fully tighten hardware at this time.

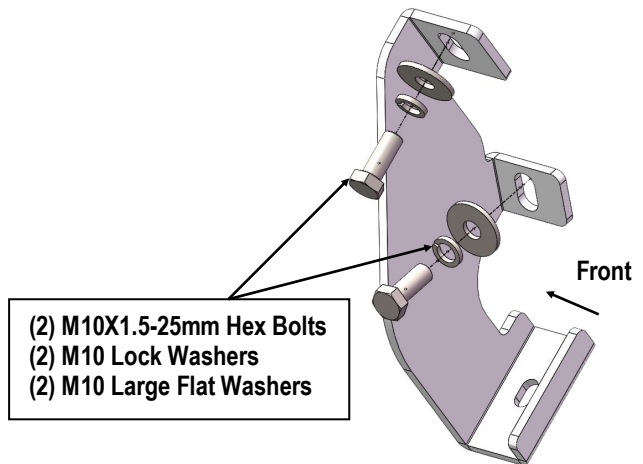

(Fig 2) Passenger Front Mounting Bracket (PFM) Installation

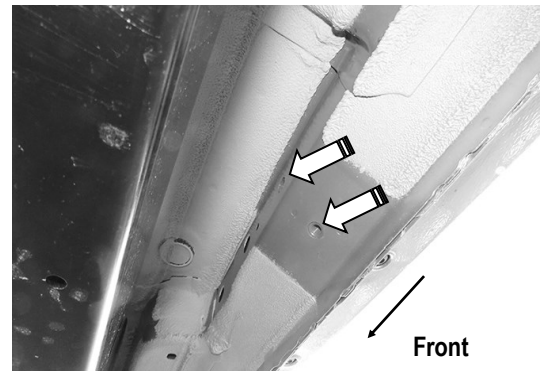

(Fig 3) Passenger Side Center Mounting Location

## STEP 3

Move to the passenger center mounting location. Attach Passenger Center Mounting Bracket (PCM/PRM) with (2)M10x1.5-25mm Hex Bolts, (2)M10 Lock Washers and (2) M10 Large Flat Washers, (Fig 3-4). Do not fully tighten hardware at this time.

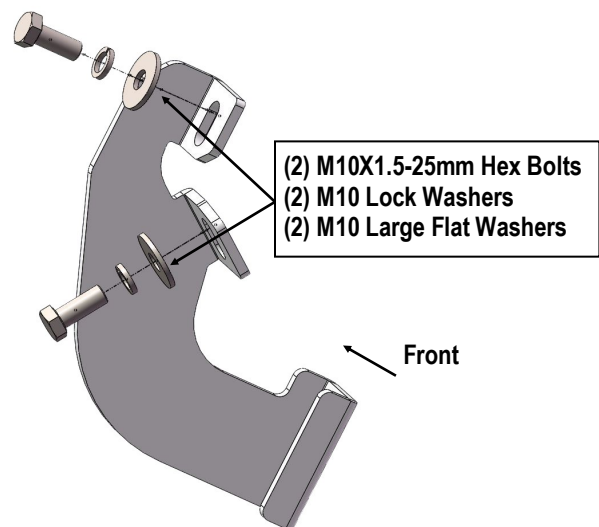

(Fig 4) Passenger Center Mounting Bracket (PCM/PRM) Installation

# iArmor®

## STEP 4

Next, move to the passenger rear mounting location. Repeat **Step 3** to install Passenger Rear Mounting Bracket (**PCM/PRM**) (**Fig 5**).

**Note:** Passenger Center Mounting Bracket and Passenger Rear Mounting Bracket are universal.

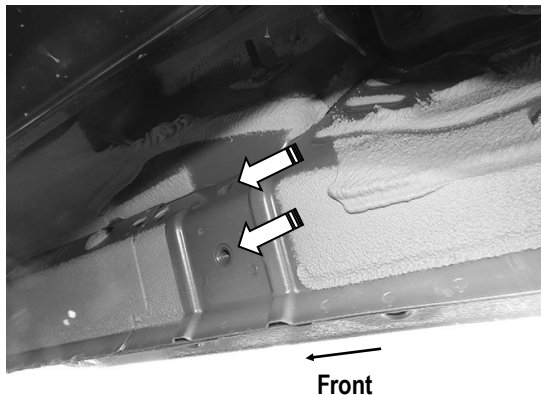

(Fig 5) Passenger Side Rear Mounting Location

## STEP 5

Once all (3) passenger side mounting brackets are installed, select and attach the Passenger Side Step Bar onto the Mounting Brackets with (3) U Brackets, (3) M8X1.25-55mm Carriage Bolts, (3) M8 Large Flat Washers, (3) M8 Lock Washers and (3) M8X1.25 Hex Nuts (**Fig 6**). Do not fully tighten hardware at this time.

## STEP 6

Properly level and adjust the Step Bar and fully tighten all hardware.

## STEP 7

Move to the driver side of the vehicle. Repeat **Steps 1-6** to install driver side step bar.

Installation completed.

### Attention

Do periodic inspections to the installation to make sure that all hardware is secure and tight.  
In order to protect your bars/boards, please use mild soap/non-abrasive products for cleaning only.

# iArmor®

