

iArmor[®]

iArmor[®] by APS

PART#: IA-S311H

BEFORE INSTALLATION

REMOVE CONTENTS FROM BOX. VERIFY ALL PARTS ARE PRESENT. READ INSTRUCTIONS CAREFULLY BEFORE STARTING INSTALLATION. ASSISTANCE IS RECOMMENDED. THANK YOU FOR CHOOSING OUR PRODUCT!

*ROCKER PANEL MOUNT

*DRILLING NOT REQUIRED

Torque Value

Fastener Size	Tightening Torque (ft-lbs)	Required
6mm	6-7	X
8mm	16-18	√
10mm	31-32	√
12mm	56-58	X
14mm	92-94	X

PART LIST

Driver Side Step Bar

Front

Passenger Side Step Bar

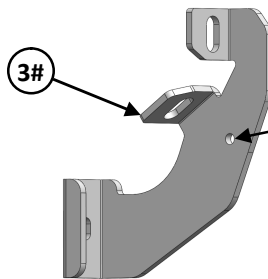
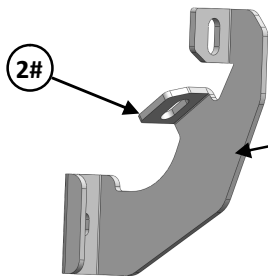
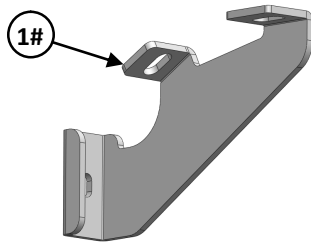
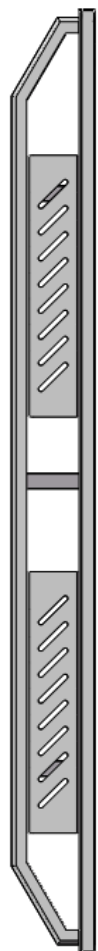

Center Mounting
Brackets W/o Hole

Rear Mounting
Brackets W/ Hole

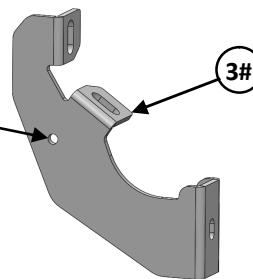
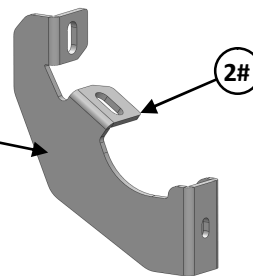
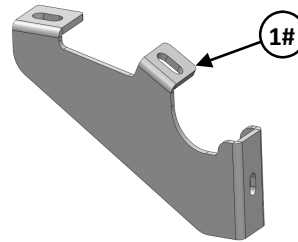

Customer Support: info@iarmorauto.com

iArmor®

Hardware Package A (For Bracket Installation)					
Item	QTY	Description	Item	QTY	Description
1#	2	Driver / Passenger Front Mounting Brackets	5#	12	M10X1.5-30mm Hex Bolts
2#	2	Driver / Passenger Center Mounting Brackets	6#	12	M10 Flat Washers
3#	2	Driver / Passenger Rear Mounting Brackets	7#	12	M10 Lock Washers
4#	6	U Brackets			

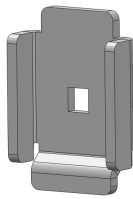

4#

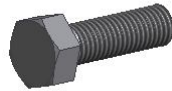

5#



6#



7#

Hardware Package B (For Step Bar Installation)					
Item	QTY	Description	Item	QTY	Description
1#	6	M8X1.25-55mm Carriage Bolts	3#	6	M8 Lock Washers
2#	6	M8 Large Flat Washers	4#	6	M8 Hex Nuts

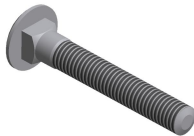

1 #



2#



3 #

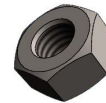

4 #

iArmor®

The instruction here is for your reference only. We strongly recommend the professional installer for best result. We are not responsible for any damage caused by the installation.

STEP 1

Start installation from the Passenger side front of the vehicle, locate the threaded holes on the body panel, (Fig 1). Remove the plastic plugs covering the holes if equipped.

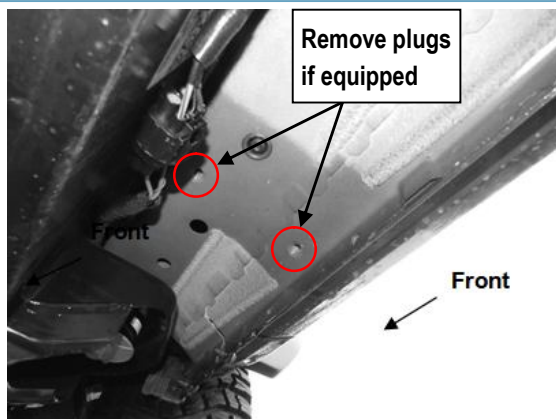

(Fig 1) Passenger Side Front Mounting Location

STEP 2

Select Passenger Front Mounting Bracket and attach it to the front mounting location with (2) M10 Hex Bolts, (2) M10 Flat Washers, (2) M10 Lock Washers, (Fig 2). Do not fully tighten hardware at this time.

Note: Passenger and Driver Front Mounting Brackets are Universal.

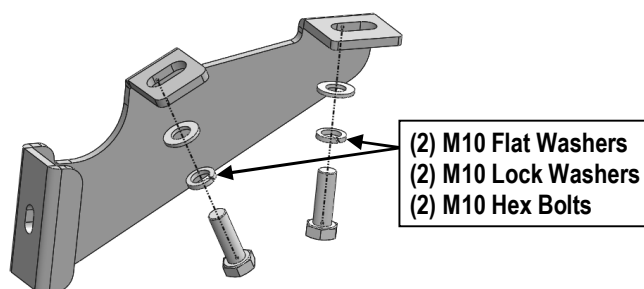

(Fig 2) Passenger Front Mounting Bracket Installation

STEP 3

Move to Passenger Side Center mounting location, (Fig 3). Repeat **Step 2** to install Passenger Center Mounting Bracket, (Fig 4). Do not fully tighten hardware at this time.

Note: Passenger and Driver Center Mounting Brackets are Universal.

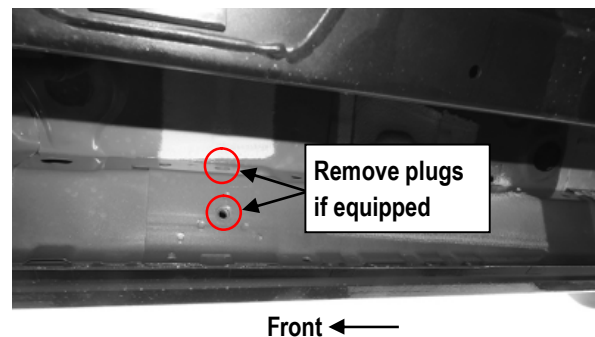

(Fig 3) Passenger Side Center Mounting Location

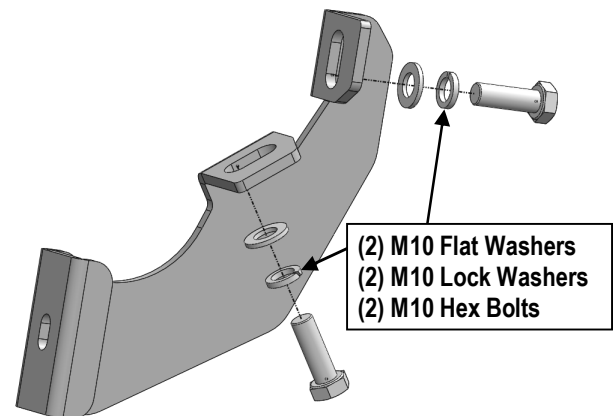

(Fig 4) Passenger Center Mounting Bracket Installation

STEP 4

Move to Passenger Side Rear mounting location, (Fig 5). Repeat **Step 2** to install Passenger Rear Mounting Bracket. Do not fully tighten hardware at this time.

Note: Passenger and Driver Rear Mounting Brackets are Universal.

iArmor®

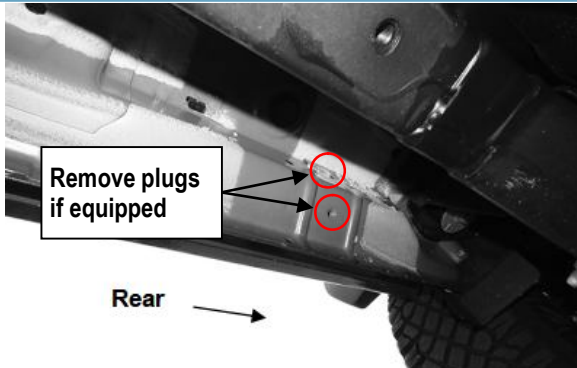

(Fig 5) Passenger Side Rear Mounting Location

STEP 5

Once all (3) passenger side mounting brackets are installed, select and attach the Passenger Side Step Bar onto the Mounting Brackets with (3) U Brackets, (3) M8X1.25-55mm Carriage Bolts, (3) M8 Large Flat Washers, (3) M8 Lock Washers and (3) M8X1.25 Hex Nuts, (Fig 6). Do not fully tighten hardware at this

STEP 6

Properly level and adjust the Step Bar and fully tighten all hardware.

STEP 7

Move to the other side of the vehicle. Repeat **Steps 1-6** to install the other side step bar.

Installation completed.

Attention

Do periodic inspections to the installation to make sure that all hardware is secure and tight.

In order to protect your bars/boards, please use mild soap/non-abrasive products for cleaning only.

NOTE: Torque all M8 X1.25-55mm Carriage Bolts to 16~18 lb-ft. Don't over tighten, or the square bars will be damaged by the brackets

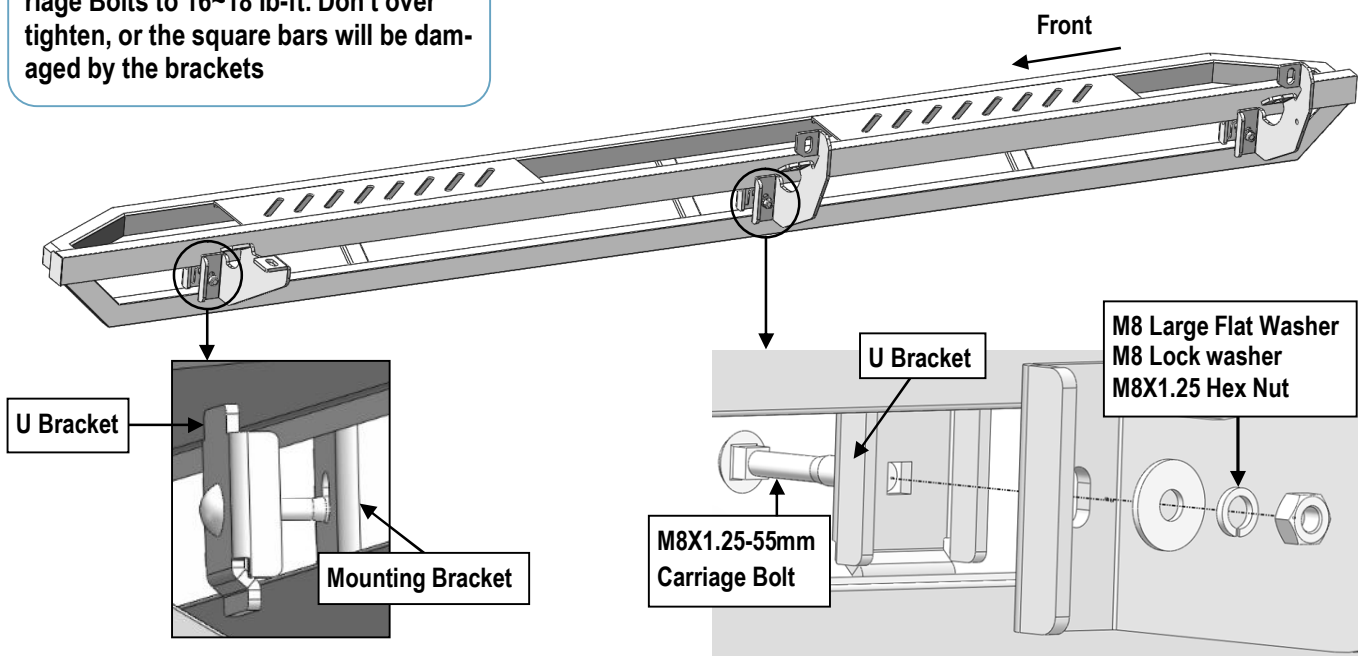

(Fig 6) Passenger Side Step Bar Installation