

iArmor[®]

iArmor[®] by APS

PART#: IA-S175H

BEFORE INSTALLATION

REMOVE CONTENTS FROM BOX. VERIFY ALL PARTS ARE PRESENT. READ INSTRUCTIONS CAREFULLY BEFORE STARTING INSTALLATION. ASSISTANCE IS RECOMMENDED. THANK YOU FOR CHOOSING OUR PRODUCT!

*ROCKER PANEL MOUNT

*DRILLING NOT REQUIRED

Torque Value

Fastener Size	Tightening Torque (ft-lbs)	Required
6mm	6-7	X
8mm	16-18	√
10mm	31-32	X
12mm	56-58	X
14mm	92-94	X

PART LIST

Driver Side Step Bar

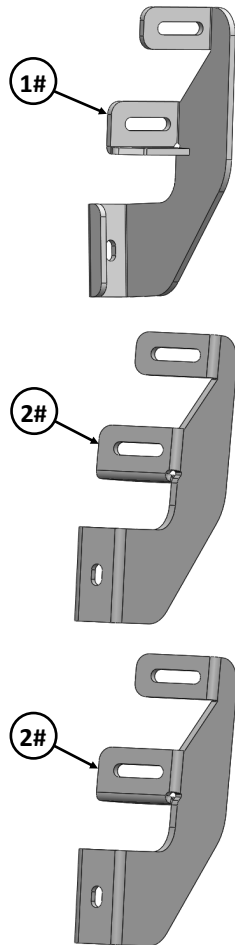
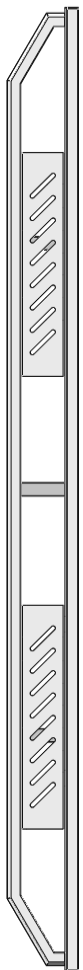

Front



Passenger Side Step Bar

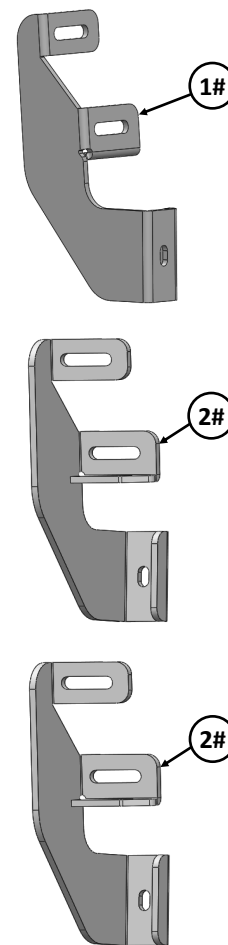

Customer Support: info@iarmorauto.com

Hardware Package A (For Bracket Installation)					
Item	QTY	Description	Item	QTY	Description
1#	2	Driver & Passenger Front Mounting Brackets	4#	12	M8 Plastic Washers
2#	4	Driver & Passenger Center / Rear Mounting Brackets	5#	12	M8 Large Flat Washers
3#	6	U Brackets	6#	12	M8X1.25 Nylon Lock Nuts

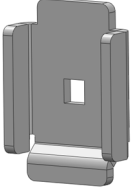

3#



4 #



5#



6 #

Hardware Package B (For Step Bar Installation)					
Item	QTY	Description	Item	QTY	Description
1#	6	M8X1.25-55mm Carriage Bolts	3#	6	M8 Lock Washers
2#	6	M8 Large Flat Washers	4#	6	M8 Hex Nuts

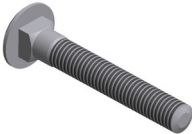

1 #



2#



3 #

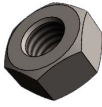

4 #

iArmor®

The instruction here is for your reference only. We strongly recommend the professional installer for best result. We are not responsible for any damage caused by the installation.

STEP 1

Start the installation from the passenger side of the vehicle. Locate the Passenger Side Front Mounting Location on the inner side of the body panel, **(Fig 1)**.

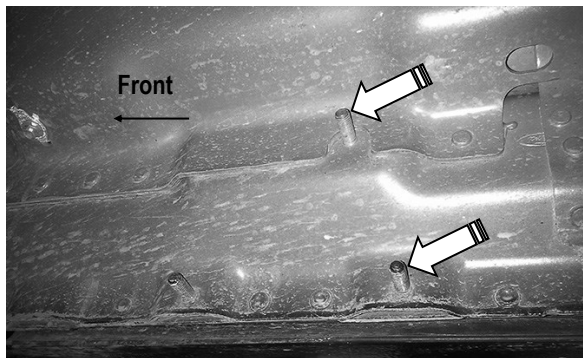

(Fig 1) Passenger Side Front Mounting Location

STEP 2

Slide (2) M8 Plastic Washers over each factory mounting studs on the body panel, **(Fig 2)**.

IMPORTANT: The Plastic Washers are designed to prevent corrosion between the body panel and the mounting brackets.

STEP 3

Attach the Front Mounting Bracket to the (2) factory studs with (2) M8 Large Flat Washers and (2) M8X1.25 Nylon Lock Nuts, **(Fig 3)**. Do not fully tighten the hardware at this time.

(2) M8 Plastic Washers Illustration

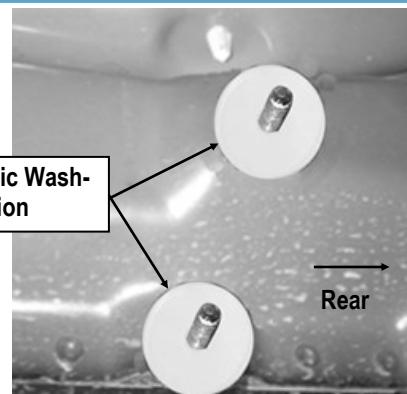

(Fig 2) Example of M8 Plastic Washers Installation (Passenger Side Rear Mounting Location)

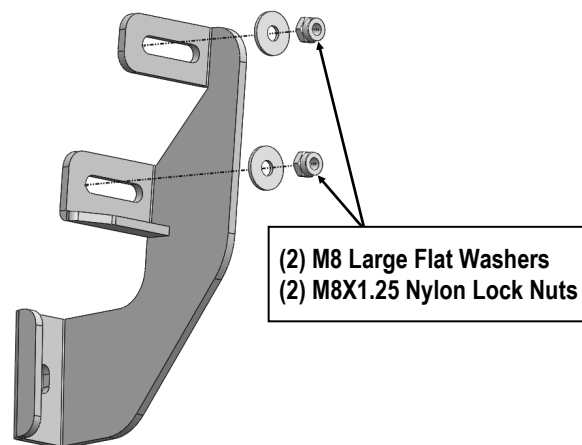

(Fig 3) Passenger Front Mounting Bracket Installation

STEP 4

Repeat **Steps 1-3** to install the (2) remaining center and rear passenger side Brackets.

STEP 5

Once all (3) passenger side mounting brackets are installed, select and attach the Passenger Side Step Bar onto the Mounting Brackets with (3) U Brackets, (3) M8X1.25-55mm Carriage Bolts, (3) M8 Large Flat Washers, (3) M8 Lock Washers and (3) M8X1.25 Hex Nuts, **(Fig 4)**. Do not fully tighten hardware at this time.

iArmor®

STEP 6

Properly level and adjust the Step Bar and fully tighten all hardware.

STEP 7

Move to the driver side of the vehicle. Repeat **Steps 1-6** to install the driver side step bar.
Installation completed.

Attention

Do periodic inspections to the installation to make sure that all hardware is secure and tight.

In order to protect your bars/boards, please use mild soap/non-abrasive products for cleaning only.

(Fig 4) Passenger Side Step Bar Installation

NOTE: Torque all M8X1.25-55mm Carriage Bolts to 16~18 lb-ft. Don't over tighten, or the square bars will be damaged by the brackets

