

iArmor®

IARMOR EDGE™

PART#: IA-N003H

BEFORE INSTALLATION

REMOVE CONTENTS FROM BOX. VERIFY ALL PARTS ARE PRESENT. READ INSTRUCTIONS CAREFULLY BEFORE STARTING INSTALLATION. ASSISTANCE IS RECOMMENDED. THANK YOU FOR CHOOSING OUR PRODUCT!

*ROCKER PANEL MOUNT

*DRILLING NOT REQUIRED

Torque Value

Fastener Size	Tightening Torque (ft-lbs)	Required
6mm	6-7	√
8mm	16-18	√
10mm	31-32	√
12mm	56-58	X
14mm	92-94	X

PART LIST

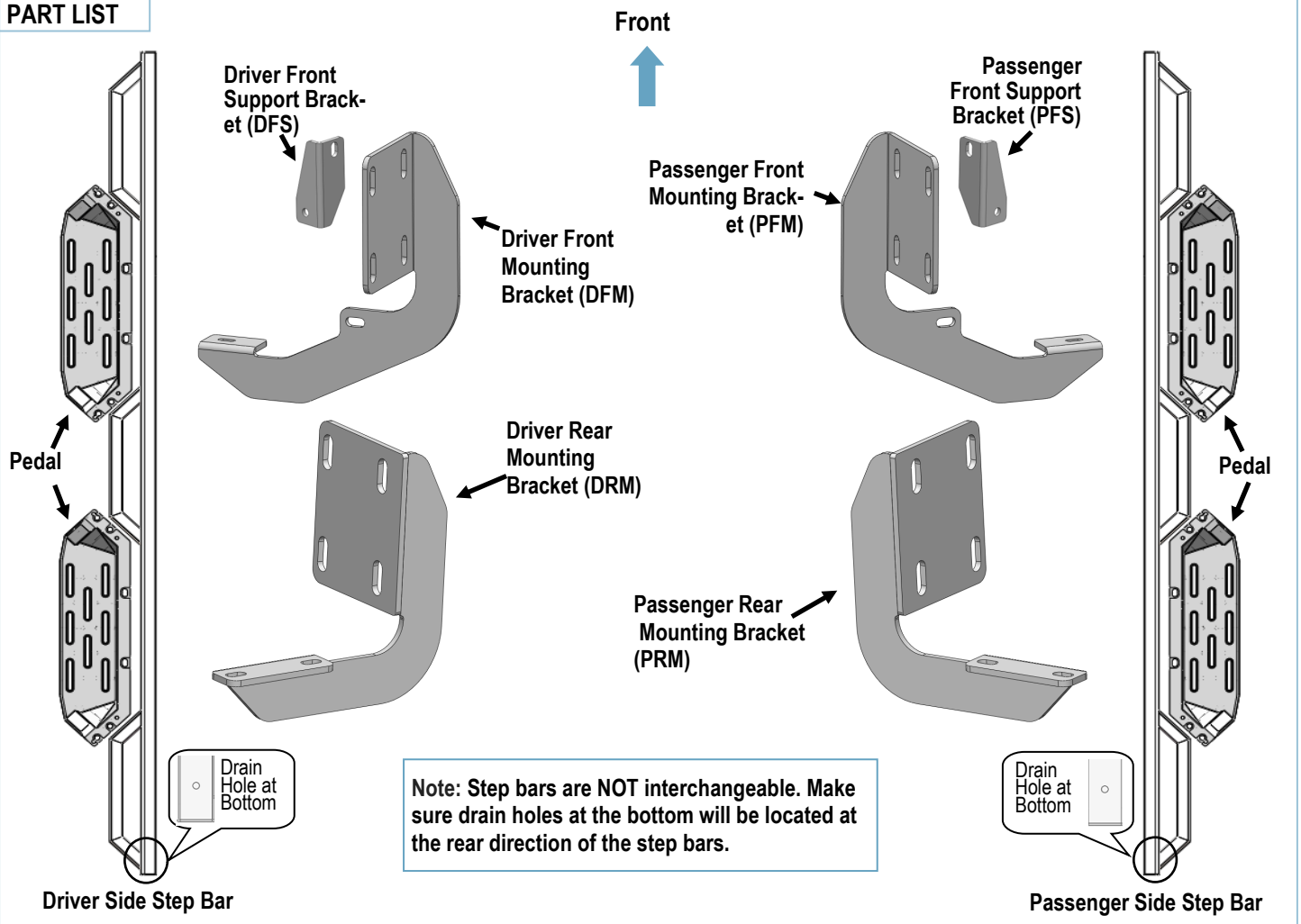



Customer Support: info@iarmorauto.com

iArmor®

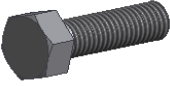
Hardware Package A (For Brackets & Bars Installation)					
Item	QTY	Description	Item	QTY	Description
1#	16	M10X1.5-30mm Hex Bolts	8#	8	M8 Nylon Lock Nuts
2#	24	M10 Large Flat Washers	9#	2	M6X1-20 Square Head Bolts
3#	8	M10 Lock Washers	10#	2	M6 Large Flat Washers
4#	8	M10 Nylon Lock Nuts	11#	2	M6 Nylon Lock Nuts
5#	8	M10 Clip Nuts	12#	6	M8X1.25-20 T Bolts
6#	2	M8X1.25-30 Hex Bolts	13#	6	M8 Plastic Washers
7#	10	M8 Large Flat Washers			



1 #



2 #

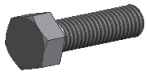

3 #



4 #



5 #

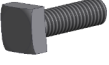

6 #



7 #



8 #

9 #



10 #



11 #

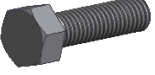

12 #

13 #

Hardware Package B (For Step Pedals Installation)					
Item	QTY	Description	Item	QTY	Description
1#	24	M8X1.25-25 Hex Bolts	3#	24	M8 Lock Washers
2#	24	M8 Large Flat Washers			

1#

2#

3#

Customer Support: info@iarmorauto.com

iArmor[®]

The instruction here is for your reference only. We strongly recommend the professional installer for best result. We are not responsible for any damage caused by the installation.

STEP 1

Install (4) Pedals onto the step bars with (24) M8X1.25-25mm Hex Bolts, (24) M8 Large Flat Washers and (24) M8 Lock Washers.

IMPORTANT: Don't punch the pedal with any metal hammer within pedal installation, or the pedal will be damaged.

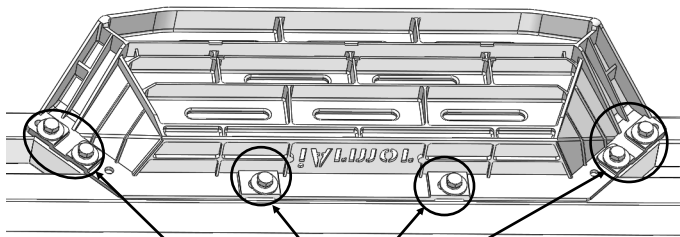

(6) M8X1.25-25 Hex Bolts
(6) M8 Large Flat Washers
(6) M8 Lock Washers

STEP 2

Start installation from the passenger side of the vehicle, locate the (4) pairs of factory holes along the pinch weld (**Figs 1 & 2**). **NOTE:** There are (4) mounting locations along the inner body panel. Running Board installation will use the 2nd and 4th mounting locations, (**Figs 1 & 2**).

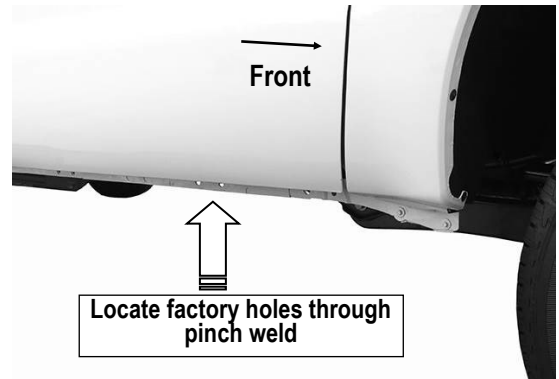

(Fig 1) Passenger Side Pinch Weld Mounting Location

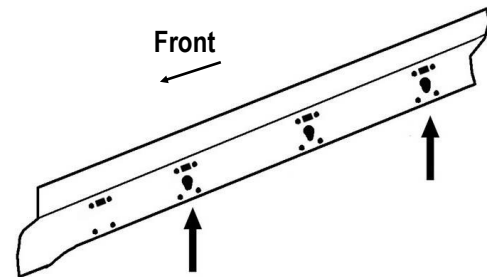

(Fig 2) Passenger Side Inner Body Panel Mounting Locations

STEP 3

Select (2) M10 Clip Nuts. Insert Clip Nuts into the rectangular opening. Line up the threaded hole on the clip nuts with the round hole next to the rectangular opening.

NOTE: The threaded nut on the Clip Nut must go towards the inside of the side panel, (**Figs 3 & 4**).

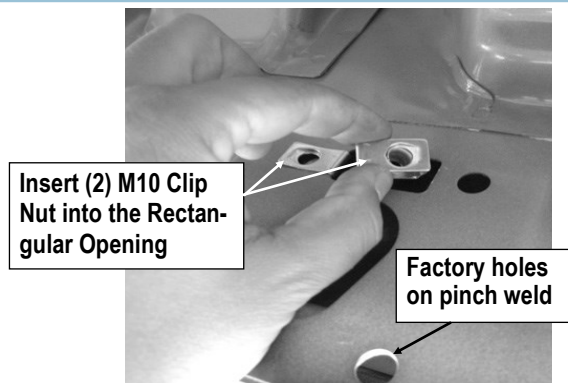

(Fig 3) Typical Mounting Location

iArmor®

STEP 5

Attach the Assembled Passenger Front Mounting Bracket to the installed M10 Clip Nuts with (2) M10X1.5-30 Hex Bolts, (2) M10 Lock Washers, (2) M10 Large Flat Washers; and secure (2) lower holes with (2) M10X1.5-30 Hex Bolts, (4) M10 Large Flat Washers (2) M10 Nylon Lock Nuts, (**Fig 6**). Do not fully tighten hardware at this time.

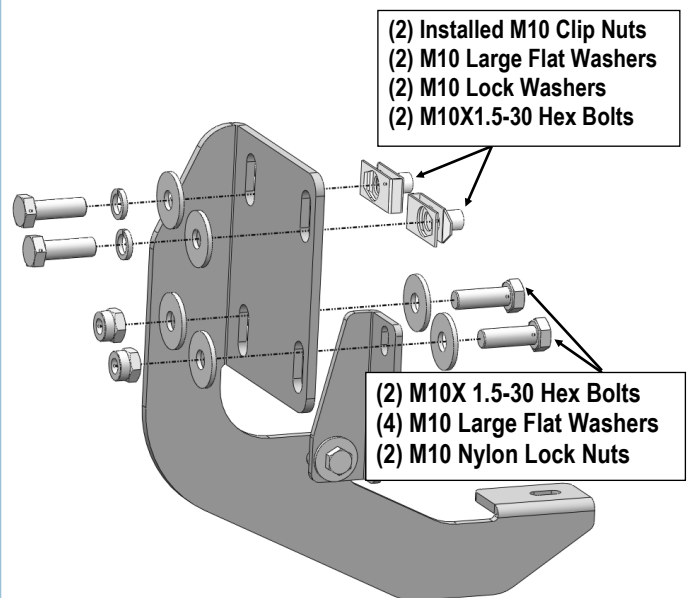

(Fig 6) Passenger Front Mounting Bracket Installation

STEP 6

Move to the Passenger Side Rear Mounting Location. Repeat **Step 5** to install the Passenger Rear Mounting Bracket (**PRM**), (**Fig 7**). Do not fully tighten hardware at this time.

Line up Clip Nuts with factory round holes

Factory holes on pinch weld pictured from behind body panel

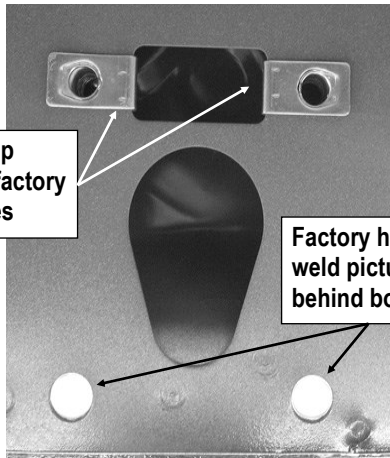

(Fig 4) M10 Clip Nut Installed

STEP 4

Assemble the Passenger Front Mounting Bracket (**PFM**) and Passenger Front Support Bracket (**PFS**) with (1) M8X1.25-30 Hex Bolt, (2) M8 Large Flat Washers, (1) M8 Lock Washer and (1) M8X1.25 Hex Nut, (**Fig 5**). Do not fully tighten hardware at this time.

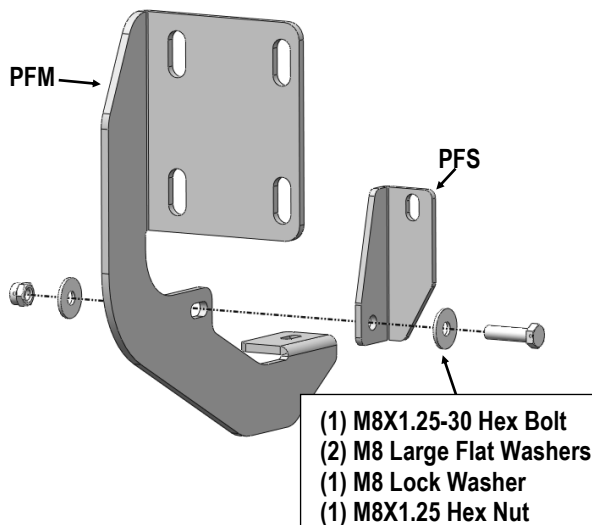

(Fig 5) Passenger Front Mounting Bracket Assembly

iArmor®

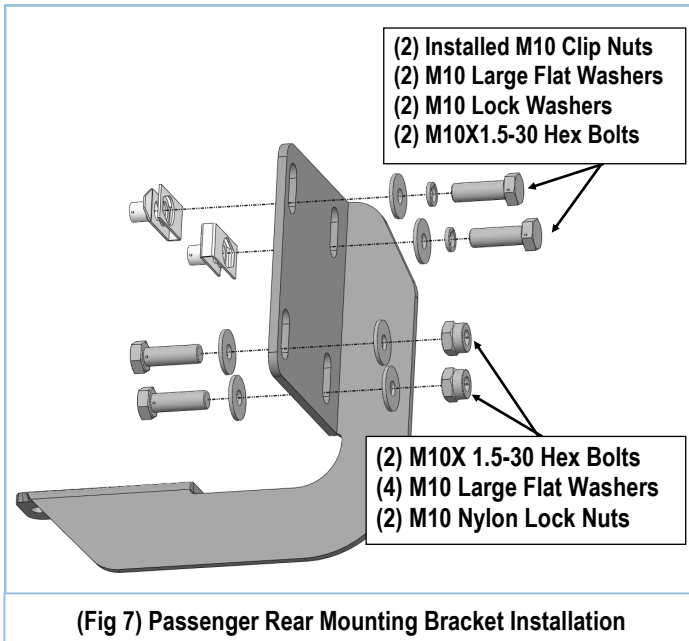

STEP 7

Once all (2) brackets have been installed, select (3) M8X1.25-20mm T-Bolts, thread (1) M8 Plastic Washer on each T-Bolt, (Fig 8). Install the (3) M8X1.25-20mm T-Bolts with plastic washers in the slots on the assembled Passenger side step bar. Rotate the T-Bolts to 90 degree, thread down the M8 Plastic Washers against the step bar (Fig 9).

NOTE: The Plastic Washer is designed to keep the T-Bolt in place to avoid falling into the tube during installation.

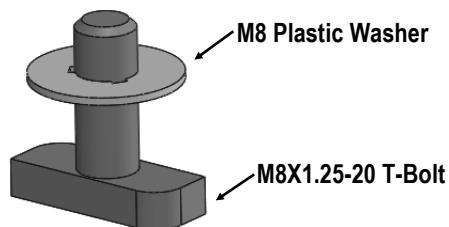

(Fig 8) Thread (1) M8 Plastic Washer on each T-Bolt Before Inserting into the slot !!!

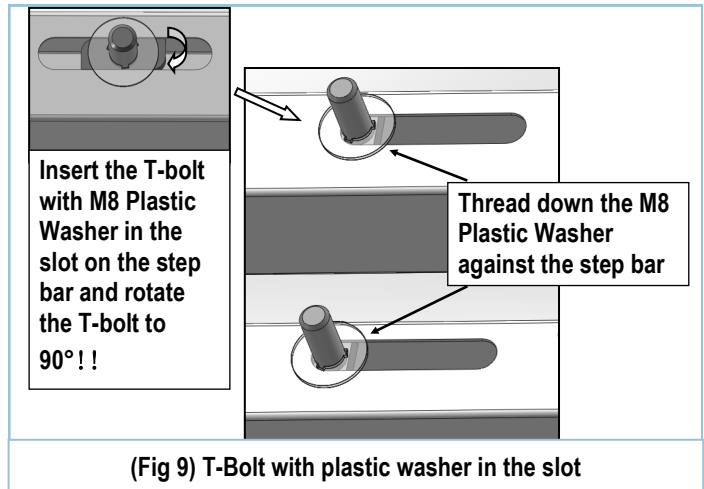

STEP 9

Attach the Assembled Passenger Side Step Bar onto the Mounting Brackets with (3) M8 Plastic Washers, (3) M8X1.25-20mm T-Bolts, (3) M8 Large Flat Washers, (3) M8 Nylon Lock Nuts, (Fig 10). Do not fully tighten hardware at this time.

NOTE: the Passenger Front Mounting Bracket is located under the front pedal. Slide (1) M6X1-20mm Square Head Bolt into the channel at the bottom of front pedal (Fig 11). And secure the Passenger Front Mounting Bracket to the pedal with (1) M6 Large Flat Washer and (1) M6 Nylon Lock Nut, (Fig 10). Do not fully tighten hardware at this time.

STEP 10

Level and adjust the assembled Step Bar properly and tighten all hardware.

Move to the other side of the vehicle. Repeat **Steps 2-9** for the other Side Step Bar installation.

Attention

Do periodic inspections to the installation to make sure that all hardware is secure and tight.

In order to protect your bars/boards, please use mild soap/non-abrasive products for cleaning only.

iArmor®

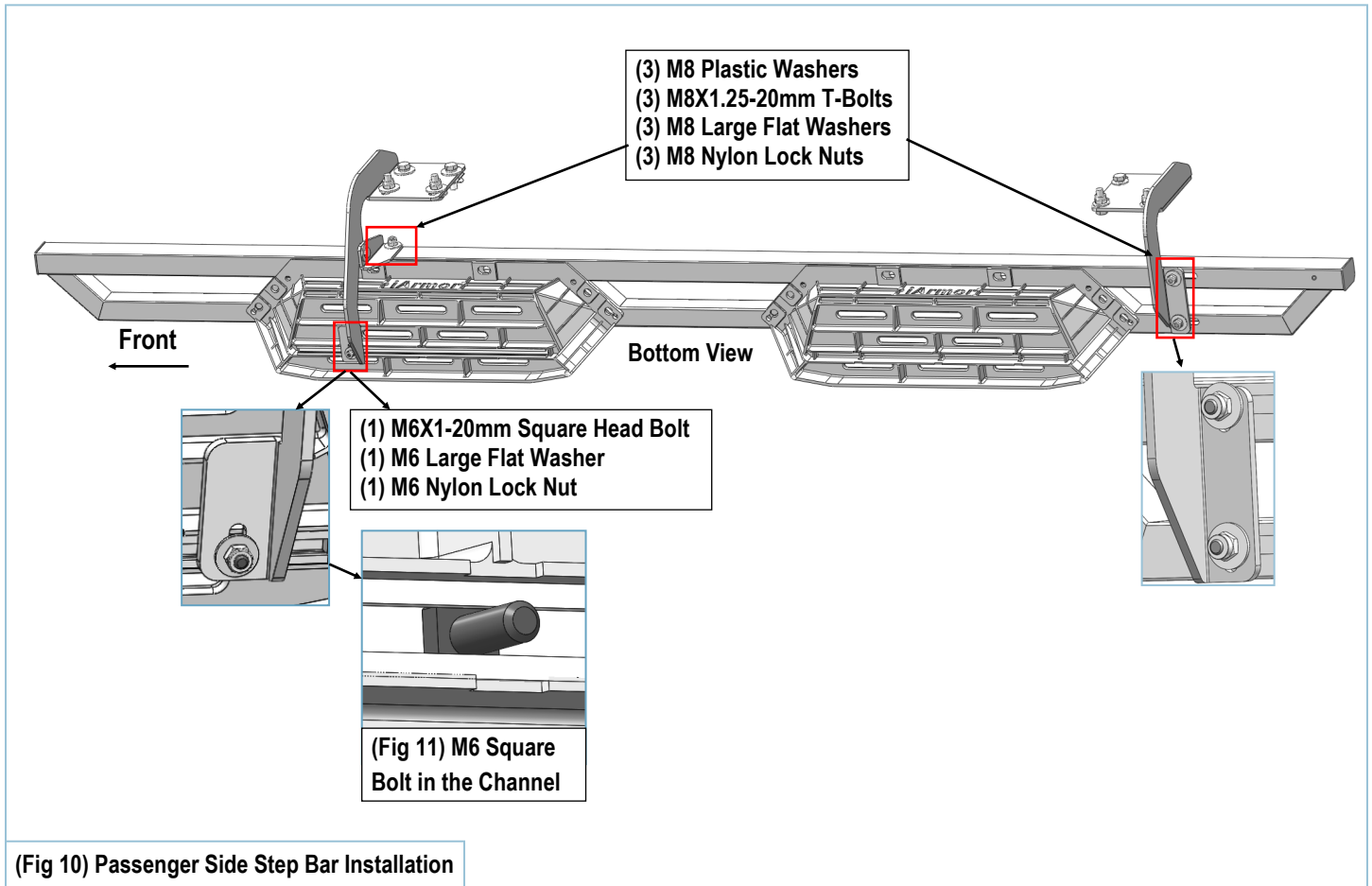

(Fig 10) Passenger Side Step Bar Installation