

iArmor[®]

IARMOR EDGE™

PART#: IA-N131H

BEFORE INSTALLATION

REMOVE CONTENTS FROM BOX. VERIFY ALL PARTS ARE PRESENT. READ INSTRUCTIONS CAREFULLY BEFORE STARTING INSTALLATION. ASSISTANCE IS RECOMMENDED. THANK YOU FOR CHOOSING OUR PRODUCT!

*BODY FRAME MOUNT

*DRILLING NOT REQUIRED

Torque Value

Fastener Size	Tightening Torque (ft-lbs)	Required
6mm	6-7	X
8mm	16-18	√
10mm	31-32	X
12mm	56-58	√
14mm	92-94	X

PART LIST

Front

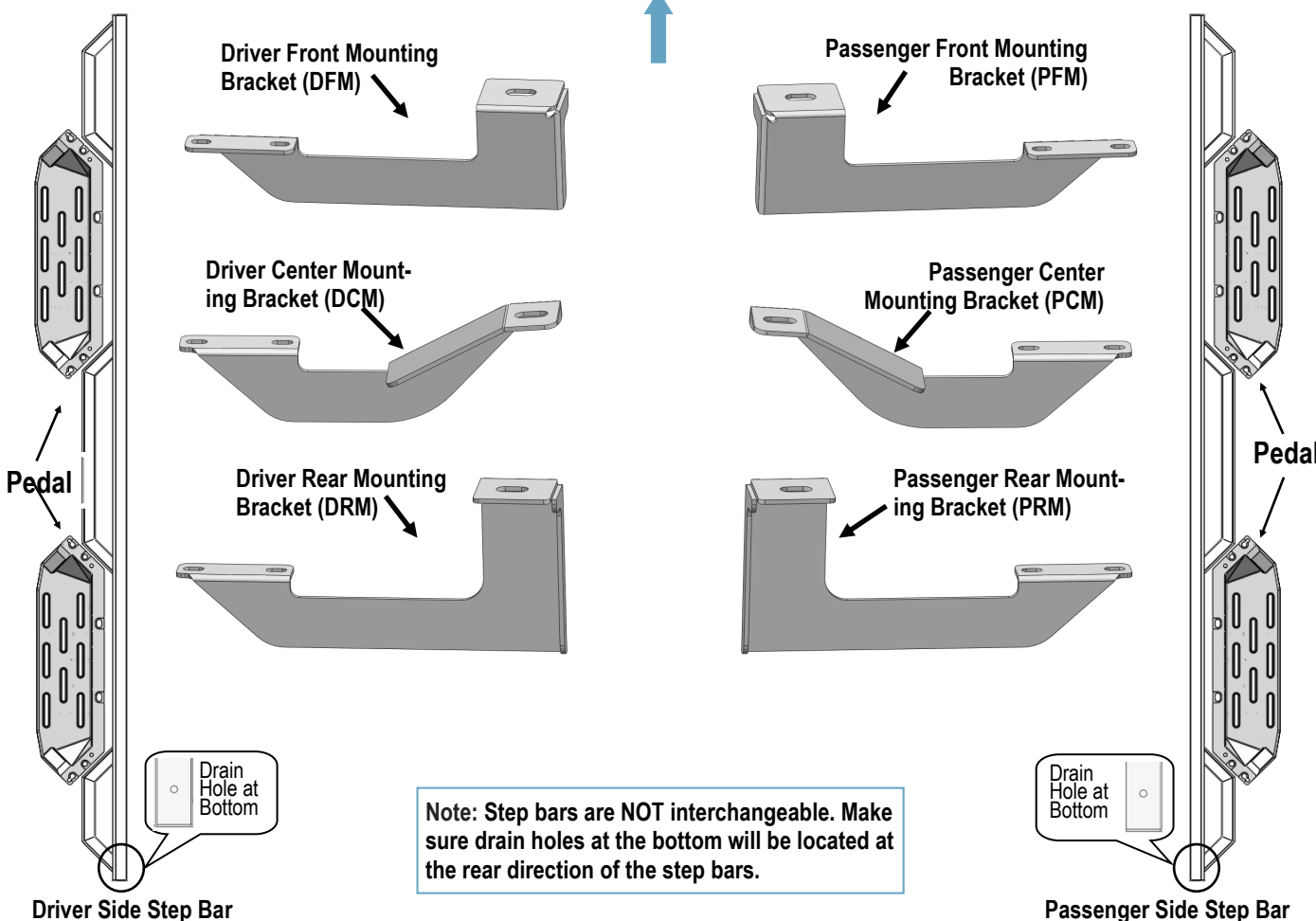







Note: Step bars are NOT interchangeable. Make sure drain holes at the bottom will be located at the rear direction of the step bars.

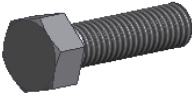

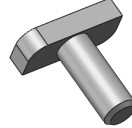
Customer Support: info@iarmorauto.com

iArmor®

Hardware Package A (For Brackets & Bars Installation)					
Item	QTY	Description	Item	QTY	Description
1#	6	M12X1.75-120 Hex Bolts	5#	12	M8 Plastic Washers
2#	6	M12 Large Flat Washers	6#	12	M8 Large Flat Washers
3#	6	M12 Lock Washers	7#	12	M8 Nylon Lock Nuts
4#	12	M8X1.25-20 T Bolts			

						
1#	2#	3#	4#	5#	6#	7#

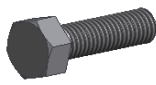
Hardware Package B (For Step Pedals Installation)					
Item	QTY	Description	Item	QTY	Description
1#	24	M8X1.25-25 Hex Bolts	3#	24	M8 Lock Washers
2#	24	M8 Large Flat Washers			

		
1#	2#	3#

iArmor®

The instruction here is for your reference only. We strongly recommend the professional installer for best result. We are not responsible for any damage caused by the installation.

STEP 1

Install (4) Pedals onto the step bars with (24) M8X1.25-25mm Hex Bolts, (24) M8 Large Flat Washers and (24) M8 Lock Washers.

IMPORTANT: Don't punch the pedal with any metal hammer within pedal installation, or the pedal will be damaged.

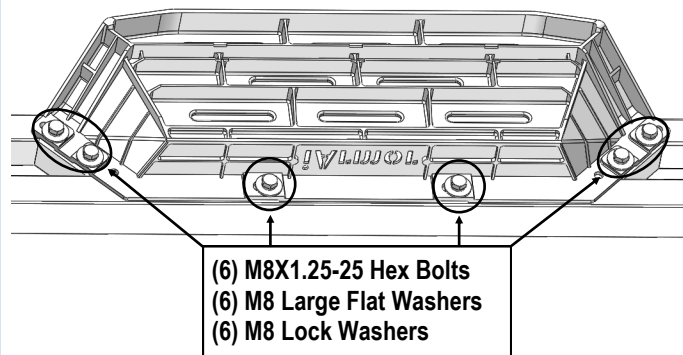

STEP 2

Start the installation from the Driver side of the vehicle. Remove the front and rear body mount hex bolts. Do not remove the rubber bushings, (Fig 1).

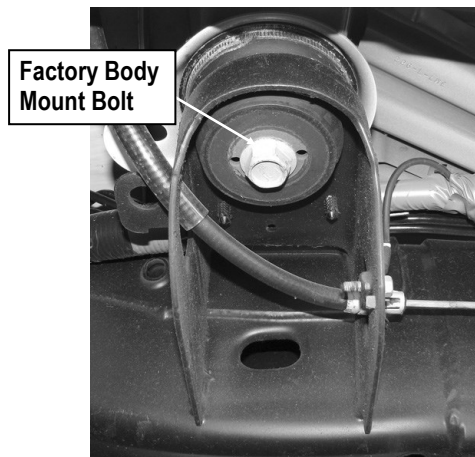

(Fig 1) Driver Side Mounting Location

STEP 3

Hang the Driver Front & Center & Rear Mounting Brackets to the body mounts using the factory hex bolts, (Fig 2).

NOTE: On some model years, the factory bolt and flat washer cannot be reinstalled due to Bracket interference. Replace the factory hex bolts and washers with the included M12X1.75-120mm Hex Bolt, M12 Lock Washers and M12 Large Flat Washers, (Fig 2). Do not fully tighten hardware at this time.

STEP 4

Once all (3) brackets have been installed, select (6) M8X1.25-20mm T-Bolts, thread (1) M8 Plastic Washer on each T-Bolt, (Fig 3). Install the (6) M8X1.25-20mm T-Bolts with plastic washers in the slots on the assembled Driver side step bar. Rotate the T-Bolts to 90 degree, thread down the M8 Plastic Washers against the step bar (Fig 4).

NOTE: The Plastic Washer is designed to keep the T-Bolt in place to avoid falling into the tube during installation.

iArmor[®]

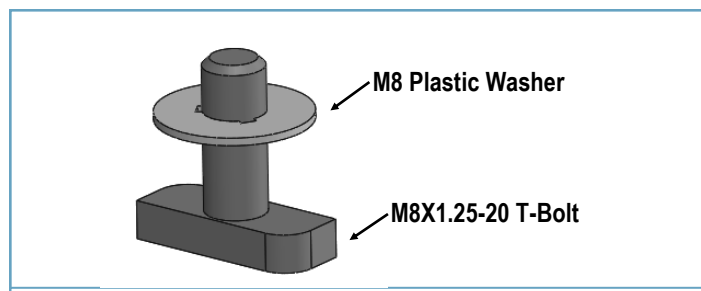
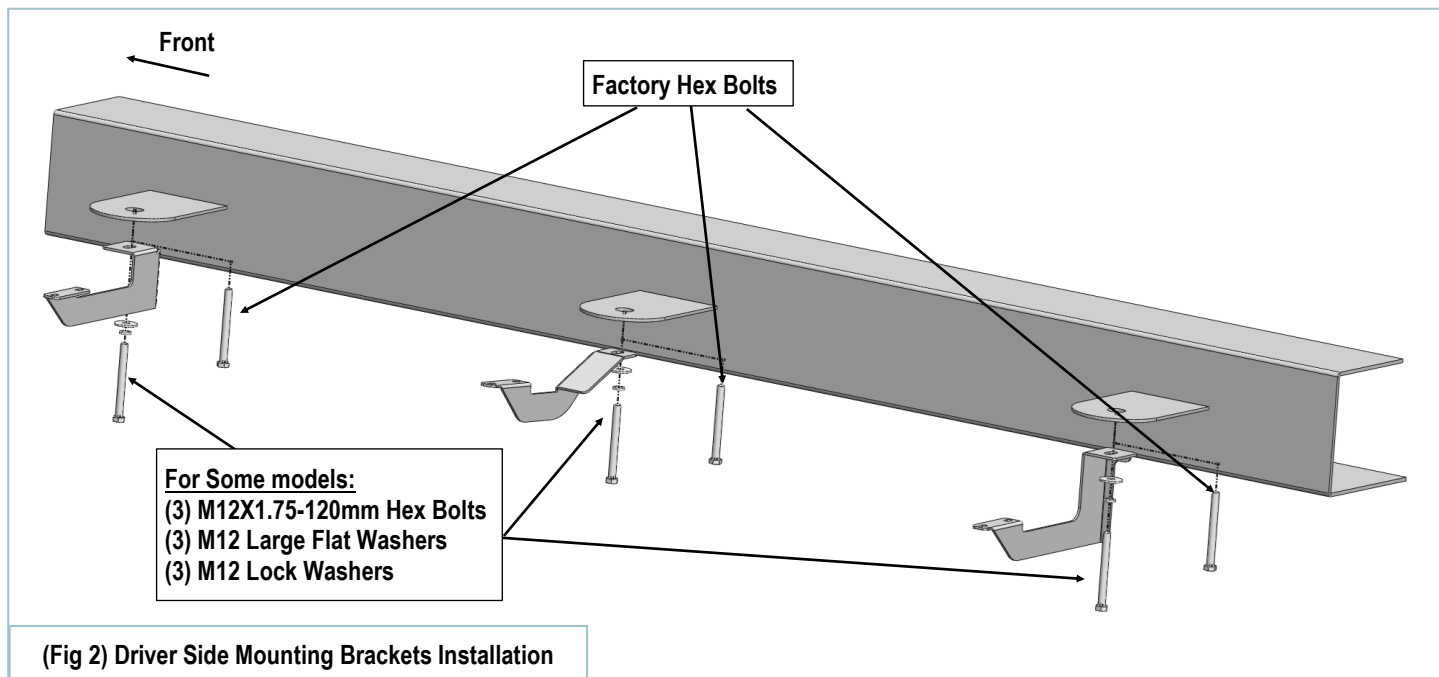

(Fig 3) Thread (1) M8 Plastic Washer on each T-Bolt Before Inserting into the slot !!!

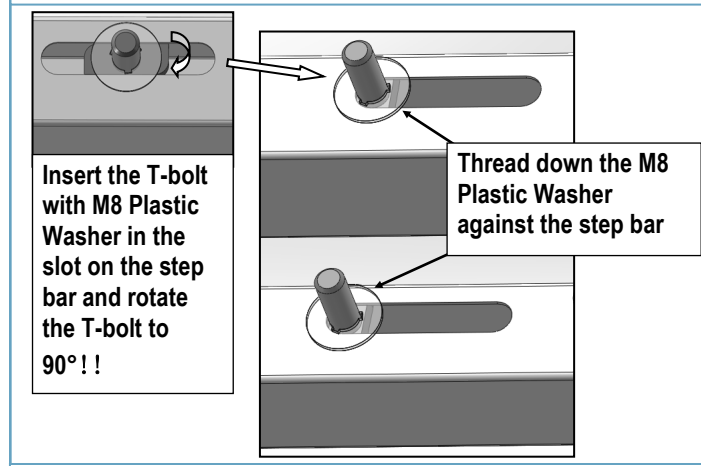

(Fig 4) T-Bolt with plastic washer in the slot

STEP 5

Attach the Assembled Driver Side Step Bar onto the Mounting Brackets with (6) M8 Plastic Washers, (6) M8X1.25-20mm T-Bolts, (6) M8 Large Flat Washers, (6) M8 Nylon Lock Nuts, (Fig 5). Do not fully tighten hardware at this time.

STEP 6

Level and adjust the assembled Step Bar properly and tighten all hardware.
Move to the other side of the vehicle. Repeat Steps 2-5 for the other side step bar installation.

Attention

Do periodic inspections to the installation to make sure that all hardware is secure and tight.

In order to protect your bars/boards, please use mild soap/non-abrasive products for cleaning only.

iArmor®

(Fig 5) Driver Side Step Bar Installation

