



Hitch Installation Instruction

REV.20240501

Part#	HT-R38783	Application	For 2011-2015 Kia Sportage (Except SX models) 2010-2015 Hyundai Tucson					
-------	-----------	-------------	--	--	--	--	--	--

Hardware List	Item	Part Name	QTY	Description	Item	Part Name	QTY	Description
	1	Conical Washers	4	M10	2	Hex Bolts	4	M10X1.25-30

Gross Load Capacity When Used As A Weight Carrying Hitch: 3500 LBS. Trailer Weight & 350 LBS. Tongue Weight.
*****DO NOT EXCEED VEHICLE MANUFACTURER'S RECOMMENDED TOWING CAPACITY.*****

*** No Trimming Required
 * No Drilling Required**

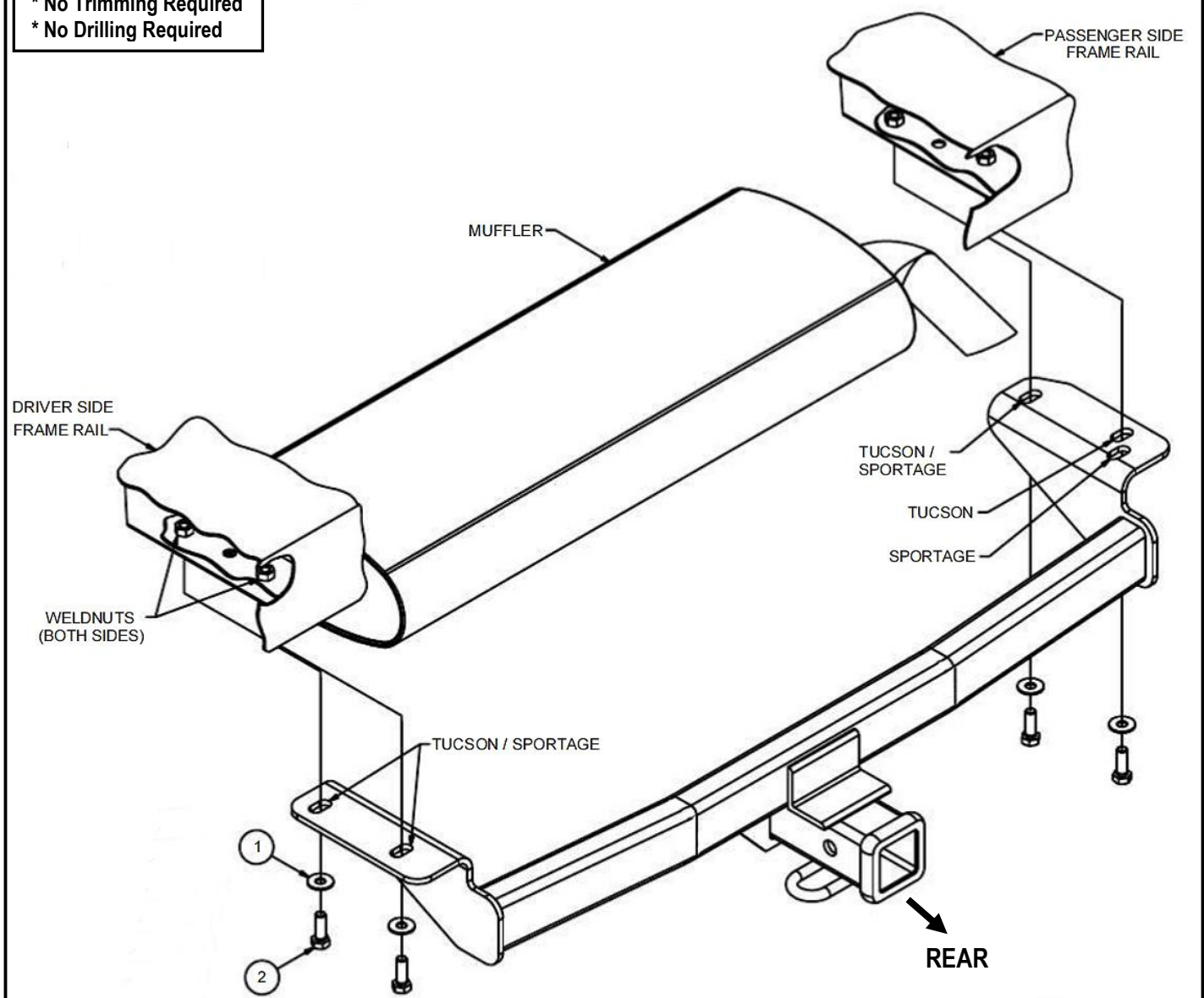

WELDNUT CLEANING

To remove debris from weldnuts in frame, spray lubricant or compressed air into hole. For heavy debris, use a small wire brush. (Be careful not to damage threads).

CONICAL TOOTHED WASHER ORIENTATION DIAGRAM





Labels: VEHICLE FRAME, HITCH SIDE PLATE, CONICAL TOOTHED WASHER, HEX BOLT

The instruction here is for your reference only. We strongly recommend the professional installer for best result. We are not responsible for any damage caused by the installation. Thank you for choosing our product!

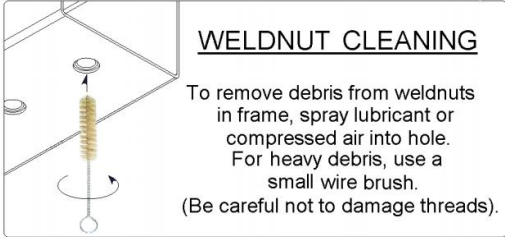

Hitch Installation Instruction

Part#	HT-R38783	Application	For 2011-2015 Kia Sportage (Except SX models) 2010-2015 Hyundai Tucson
-------	-----------	-------------	--

Step	Description
1	Locate weldnuts in frame rails. (See Weldnut Cleaning Diagram)
	 
2	Raise hitch into position aligning holes in side plates with weldnuts and secure using M10-1.25 x 30mm bolts and M10 conical washers. Note: For ease of installation, raise passenger side first then driver side.
	 
3	Torque all M10 fasteners to 48 ft-lbs. Installation Complete.
	 
<p>***Periodically Check The Receiver Hitch To Ensure That All Fasteners *** Are Tight & All Structural Components Are Sound.</p>	

The instruction here is for your reference only. We strongly recommend the professional installer for best result. We are not responsible for any damage caused by the installation. Thank you for choosing our product!