



Hitch Installation Instruction

REV.20240501

Part#	HT-R34015	Application	For 2010-2016 Cadillac SRX
-------	------------------	-------------	-----------------------------------

Hardware List	Item	Part Name	QTY	Description	Item	Part Name	QTY	Description
	1	Hex Bolts	6	M12X1.75-30	2	Conical Washers	6	M12

Gross Load Capacity When Used As A Weight Carrying Hitch: 5000 LBS. Trailer Weight & 500 LBS. Tongue Weight.
 Gross Load Capacity When Used As A Weight Distribution Hitch: 6000 LBS. Trailer Weight & 600 LBS. Tongue Weight
*****DO NOT EXCEED VEHICLE MANUFACTURER'S RECOMMENDED TOWING CAPACITY.*****



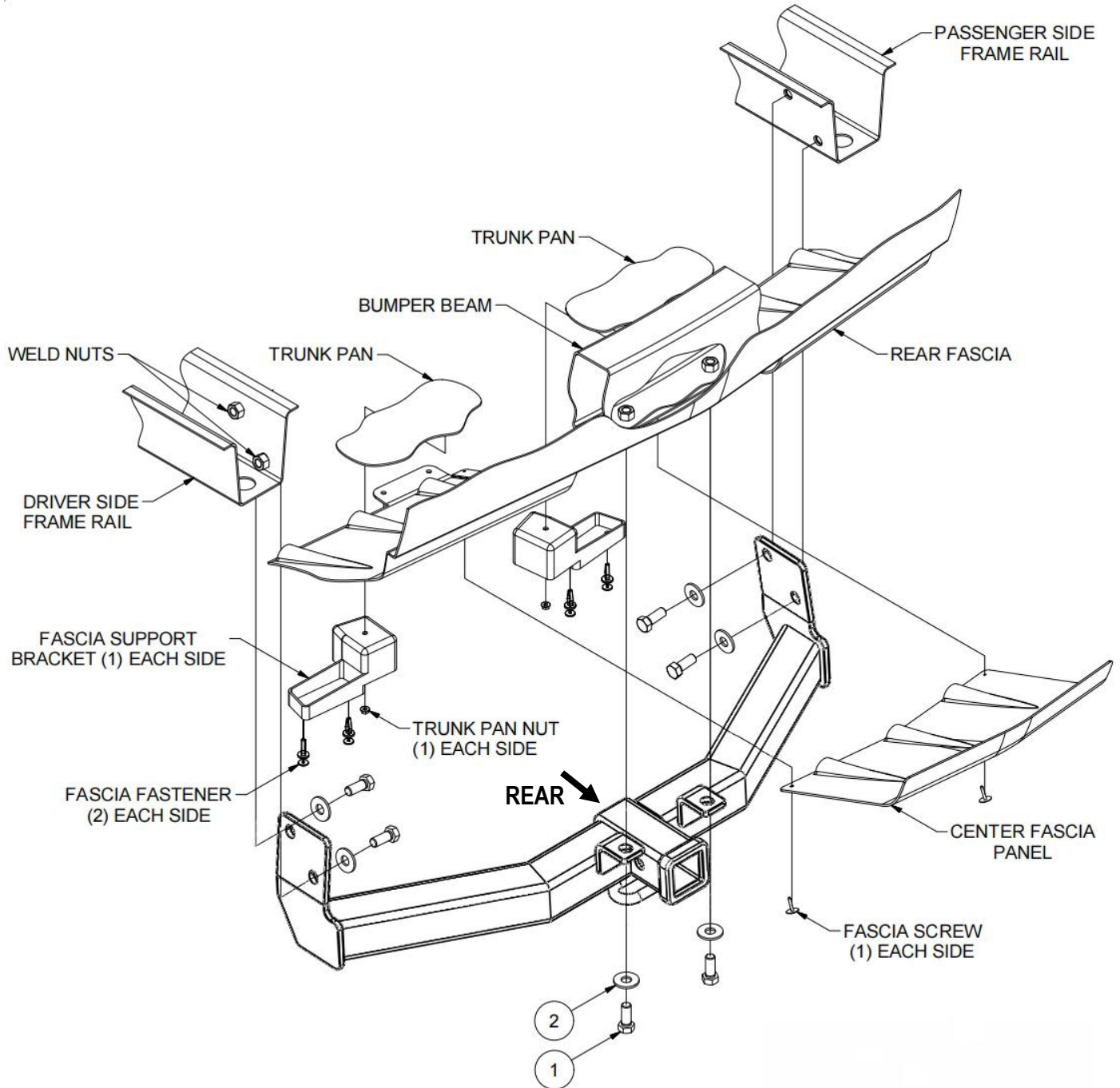





- * No Trimming Required
- * No Drilling Required



The instruction here is for your reference only. We strongly recommend the professional installer for best result. We are not responsible for any damage caused by the installation. Thank you for choosing our product!



Hitch Installation Instruction

Part#	HT-R34015	Application	For 2010-2016 Cadillac SRX
Step	Description		
1	Using a phillips screw driver remove (2) screws securing the center fascia panel. Release center fascia panel tabs and remove panel.		
			
2	If you are going to install a trailer wiring harness do this prior to installing hitch.		
			
3	Using flat blade screw driver remove (4) plastic push fasteners securing the rear fascia to the fascia support brackets. Using a 10mm socket remove the (2) nuts securing the fascia support brackets to the trunk pan.		
			
4	Pull down on rear fascia and remove fascia support brackets. The second photo shows the hardware removed. Note: Use masking tape to protect vehicle finish. Brackets will be reinstalled in Step 6.		
			

The instruction here is for your reference only. We strongly recommend the professional installer for best result. We are not responsible for any damage caused by the installation. Thank you for choosing our product!

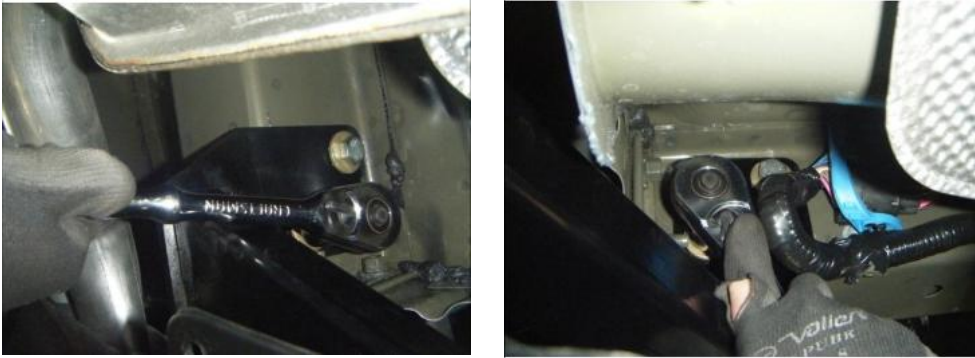
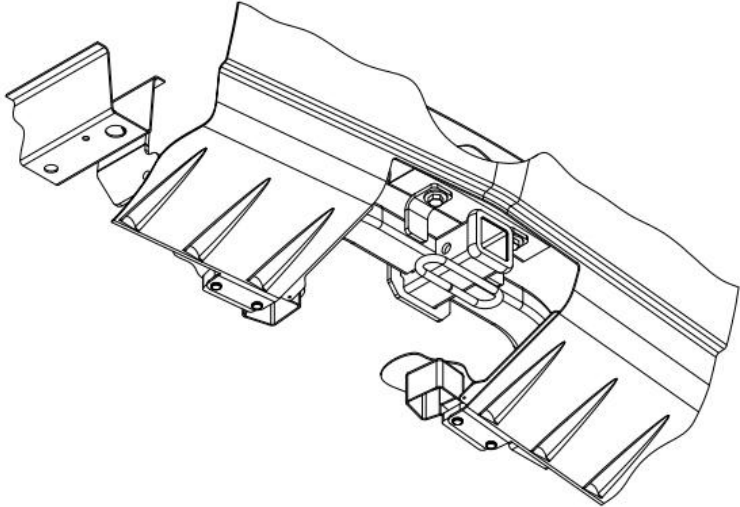

Hitch Installation Instruction

Part#	HT-R34015	Application	For 2010-2016 Cadillac SRX
5	Raise hitch into position and secure using M12-1.75 x30mm bolts and M12 conical washers. Note: Slide the driver side plate between the wiring harness and the driver side frame rail. You may need to pull down on rear fascia to slide hitch between the trunk pan and fascia.		
			
6	Reinstall fascia support brackets and fasteners. Torque all M12 fasteners to 86 ft-lbs.		
			
7	Hitch installed properly. Return center fascia panel and fasteners to owner.		
8	Installation is now complete.		
			
HITCH SHOWN INSTALLED			
***Periodically Check The Receiver Hitch To Ensure That All Fasteners *** Are Tight & All Structural Components Are Sound.			

The instruction here is for your reference only. We strongly recommend the professional installer for best result. We are not responsible for any damage caused by the installation. Thank you for choosing our product!